

MORELLI[®]

M A D E I N I T A L Y

MORELLI HISTORY

Morelli trademark was formed 80 years ago in the Italian city of Florence. Today, the company is run by representatives of the fourth generation of the Morelli family: the Cesare and Paolo brothers, demonstrating one of the most advanced and brilliant enterprises of modern Italian industry.

The company's achievements in the field of design have received international recognition. Paolo Morelli, the head of the company **Morelli**, which is one of the leaders in the production of door hardware, was born in 1967 in Florence. He received an excellent education in Switzerland. Then he worked for many years in a family business founded by his great-grandfather. Since 1993, he became a member of the Board of Directors of **Morelli** and in 1995 its President. In 1973, Cesare Morelli was born, who received an excellent artistic education and in 2000 became the chief designer of the company **Morelli**. Cesare, subtly feeling the demands of the market, invited the leading modern designers to realize their fantasies and create a door hardware that combines the sophistication of forms and decent quality. The result surpassed all the wildest expectations—door hardware **Morelli** firmly won the hearts of consumers with good taste, which allowed the company to take one of the leading places in the industry.

In 2018, **Morelli** decided to enter the **USA** market, as one of the most dynamically developing in the world, in order to give customers the joy of touching the high art.

The General catalog that you hold in your hands is the result of many years work of the whole **Morelli** team and includes more than 17,000 items.

100%
ITALIAN
MANUFACTURE





NEW COLORS



BGOS DARK BRONZE MATT



BNO BLACK BRONZE MATT



RAA ANTIQUE COPPER



BOS BRONZE MATT WITH EDGES



RAL BRIGHT COPPER



RAS SATIN COPPER



OTL POLISHED BRASS



FEA ANTIQUE IRON



NIK NICKEL

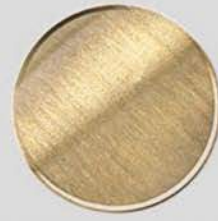

BGO BRUSHED BRONZE MATT



OSA SATIN BRASS



NIS SATIN NICKEL



ROD RHODIUM



CRO CHROME PLATED



OBR COFFEE



CSA SATIN CHROME



NIN BLACK CHROME



OBA ANTIQUE BRONZE



ORO 24K

Gilding 999 samples (24 carats). The technology of electrochemical gilding of metals allows you to create a coating with an improved structure, resistant to corrosion and mechanical stress. Gold coating gives the product additional value and improves its strength characteristics.



PIF FINISH

Morelli presents PIF—a new finish that does not erases with time. PIF—perfect indelible finish – is a highly effective treatment to protect the color and smoothness of the finish for a long time.



ABF - ANTIBACTERIAL FINISH

Antibacterial finish

The finish of silver and copper alloys with antibacterial properties was created to achieve a high level of hygiene in homes and medical establishments.

Living space

Silver refinement and beauty in interior handles. Handles with nanosilver finish (purity 99.99%), which prevents the spread of infections, destroying bacteria, fungi and mold. Silver ions destroy germs.

Medical establishment

Thanks to the nanosilver finish, 99.9% of bacteria and microbes that cause infections die in two hours. The effectiveness is confirmed by tests conducted in medical institutions, schools and sports facilities.



■ TITI CUSATELLI



■ MAURIZIO GIORDANO / ROBERTO GROSSI



■ PAOLO PEDRIZZETTI



■ SIMON QUICK



■ STUDIO HOT LAB



■ DORINA CAMUSSO



■ ITAMAR HARARI



■ MARIO MAZZER



■ DAVIDE MERCATALI



■ MAURO ARTUSIO



■ VALENTINA DOWNEY



■ MASSIMILIANO E DORIANA
FUKSAS



■ SOTTASS ASSOCIATI



LE BOAT HM
18

MIRROR HM
20

PLANET HM
22

BRILLIANCE HM
24

CULLINAN
28

MOUNTAIN OF LIGHT
30

DIADEMA
32

DOLCHE VITA
34

BRILLIANCE
36

ALLURE
40

CHAMPS-ELISEES
42

LOUVRE
44

GALACTIC
48

SPUTNIK
50

SPACE
52

SOYUZ-APOLLO
54

VOSTOK1
56

HARMONY
60

LE BOAT
62

WATERFALL
64

HORIZONT
66

FIORD
68

BRITISH STYLE
70

PLANET
74

RAFT
76

SIMPLE-S
78

INFINITY
80

RAIN
82

MATRIX
84

SUNRISE
86

TENDER
88

LUNCH
90

HILL
92

WAVE
94

MATRIX-2
96

ISLAND
98

STONE
100

ABUNDANCE
102

MURANO
104

TREE
106

WIND
108

ROCK
110

CLOUD
112

LEON
114

LANGOUST
116

BOLID
118

GOLF
120

DALI
122

SAIL
124

FLAMINGO
126

COBRA
128

SAND
130

DREAM
132

ARCH
134

COCKATOO
136

RAFT
138

VENERA
140

BUD
142

LE MANS
144

NIRVANA
146

AIR
148

PETRA
150

SIENA
152

STELLA
154

GAVANA
156

LUNA
158

TELESCOPE
160

PINOKKIO
162

SNAKE
164

VERONICA
166

ORCHIDEA
168

CALLA
170

IDRO
172

RIVA
174

ERICA
176

ASTRO
178

IRIS
180

UOVO
182

TOSCANA
184

LINDA
186

FRANCY
188

IMOLA
190

DERBY
192

RUBINO
194

RING
196

LILLA
198

PLAZA
200

BAROCCO
202

PATRICIA
204

MARY
206

CERAMICA
208



NEW COLLECTION

HANDMADE

THE MOST DARING IDEAS OF HOME DESIGN BECOME A REALITY THANKS TO THE TECHNOLOGY OF VOLUMETRIC DECORATION OF DOOR HANDLES HAND MADE, DEVELOPED BY MORELLI. TAKING AS A BASIS ONE OF THE FAVORITE HANDLES OF THE BRAND, YOU CAN MAKE IT UNIQUE – BECAUSE THE MASTER APPLIES THE SELECTED PATTERN (OR INSCRIPTION) MANUALLY. THE TECHNOLOGY OF MELTING THE ORNAMENT ON THE SURFACE GUARANTEES THE HIGHEST QUALITY AND DURABILITY



126 €

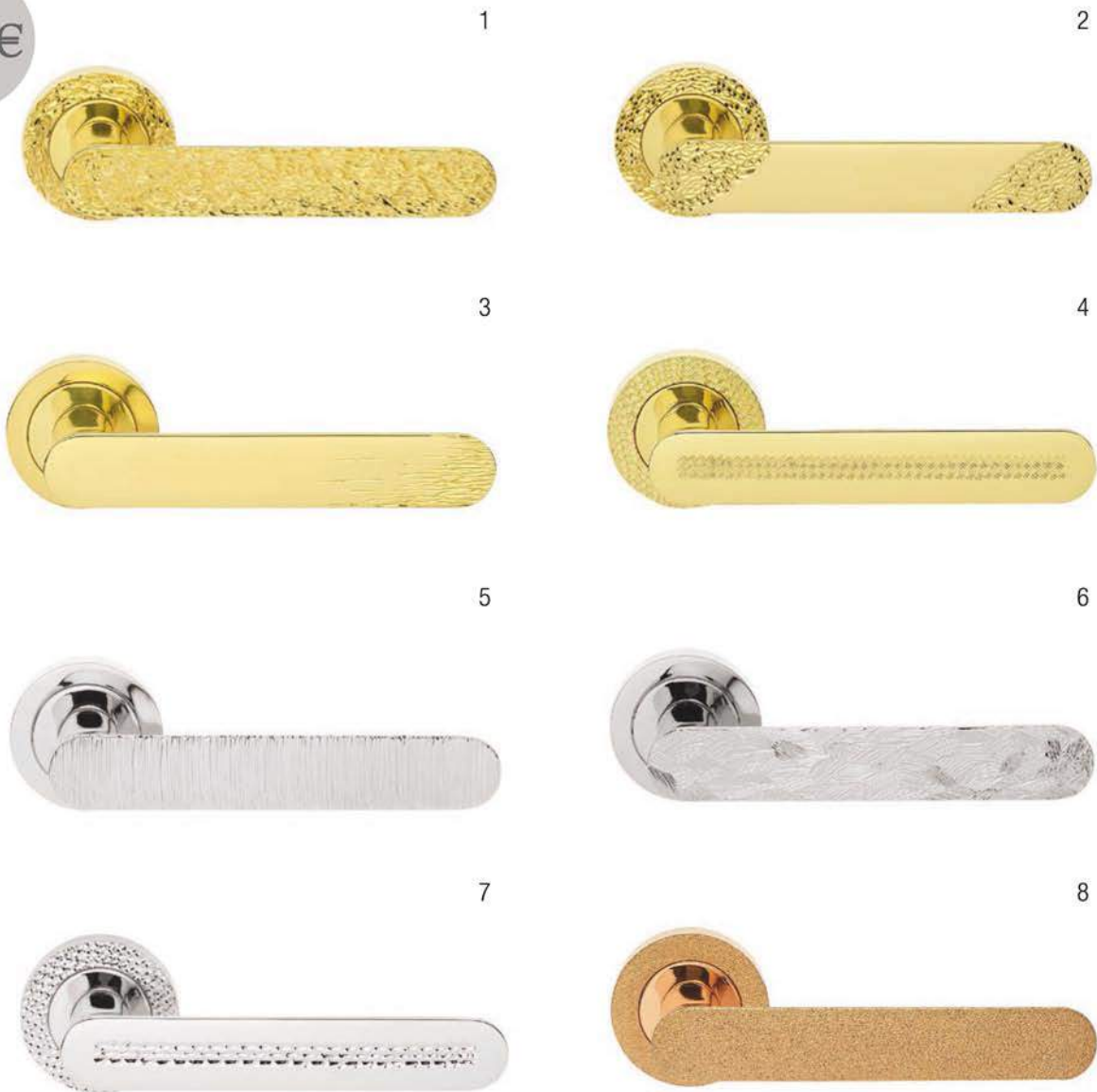

12

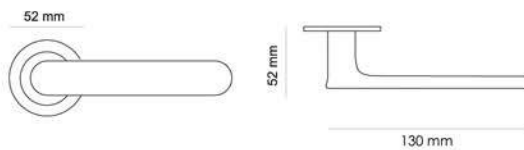

LE BOAT HM R1
 Maniglia su rosetta con bocchetta
 Door lever handle
 with rosette and escutcheon

LE BOAT HM®

Designer Mario Mazzer



MORELLI®
MADE IN ITALY



154 €

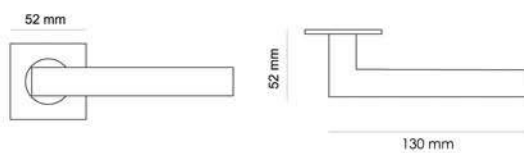
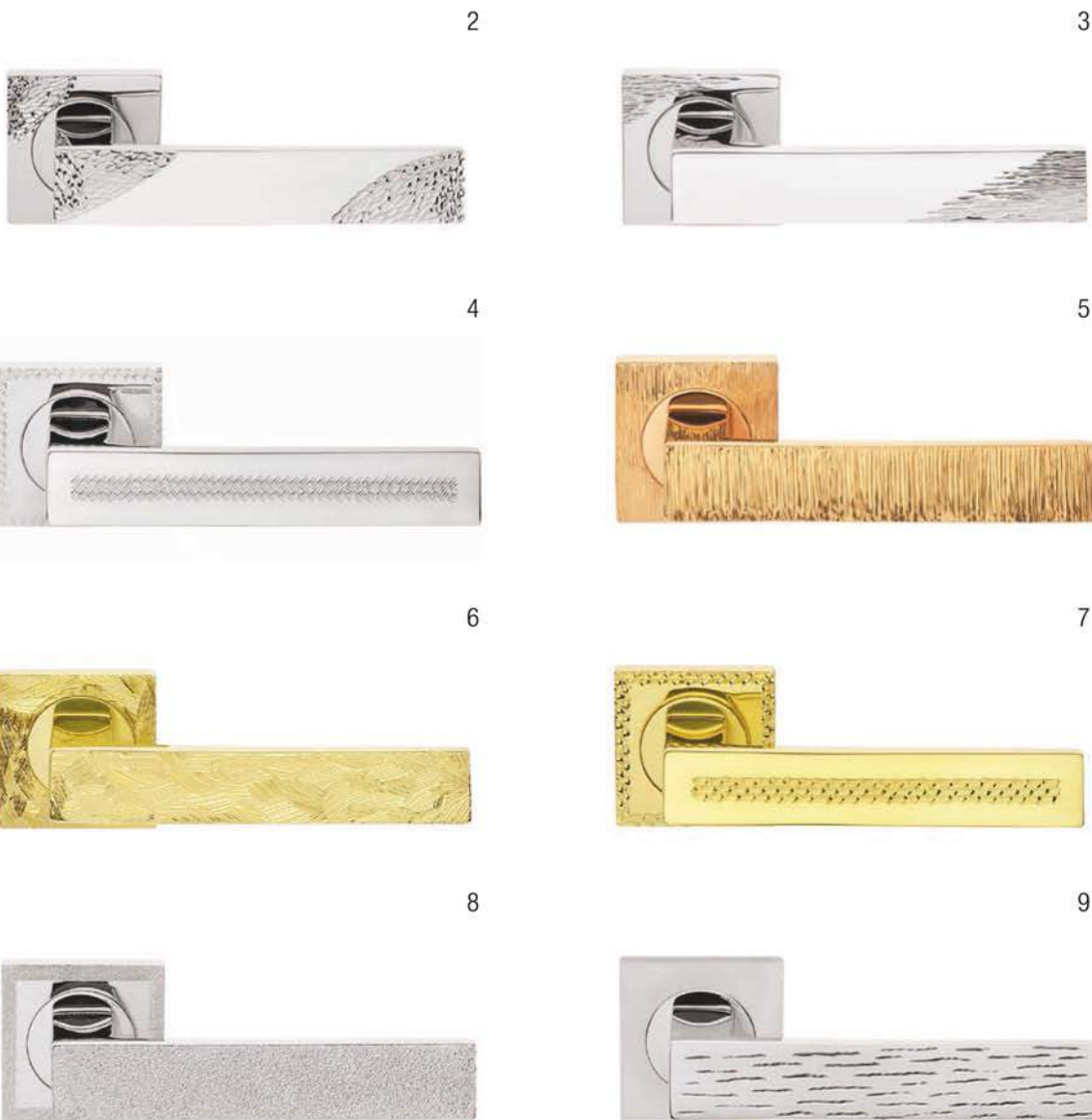

MIRROR HM S2
 Maniglia su rosetta con bocchetta
 Door lever handle
 with rosette and escutcheon

MIRROR HM[®]

Designer Mario Mazzer



MORELLI[®]
MADE IN ITALY

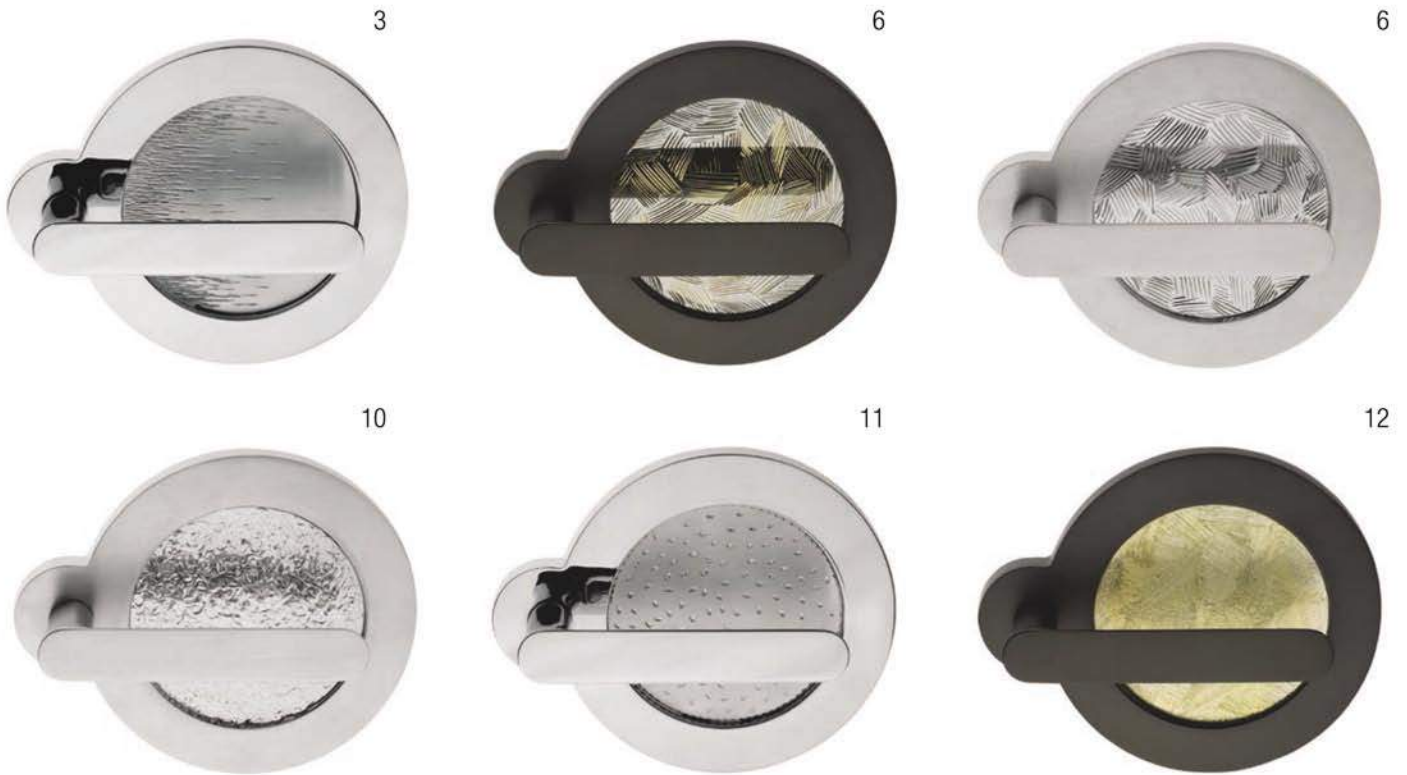

220 €

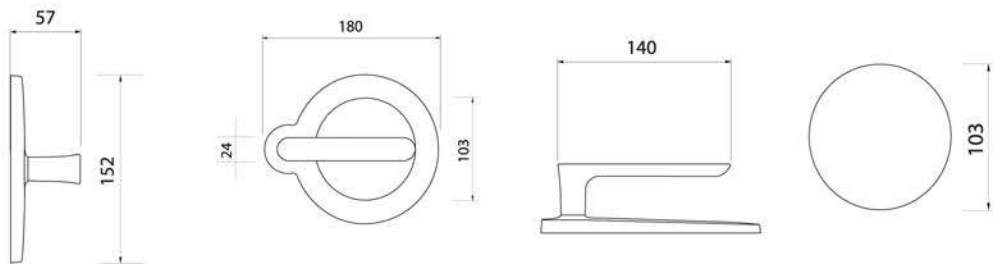

PLANET HM®

Designer Mario Mazzer



MORELLI®
MADE IN ITALY



396€

3

8

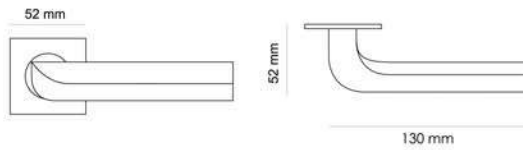

BRILLIANCE HM S2
Maniglia su rosetta con bocchetta
Door lever handle
with rosette and escutcheon

6

8

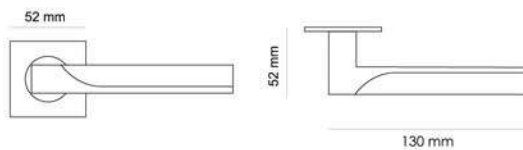

PLATEAU HM S2
Maniglia su rosetta con bocchetta
Door lever handle
with rosette and escutcheon

BRILLIANCE HM®

Designer Mario Mazzer



PLATEAU HM®

Designer Mario Mazzer



MORELLI®
MADE IN ITALY



DIAMOND CO

DIAMOND CO

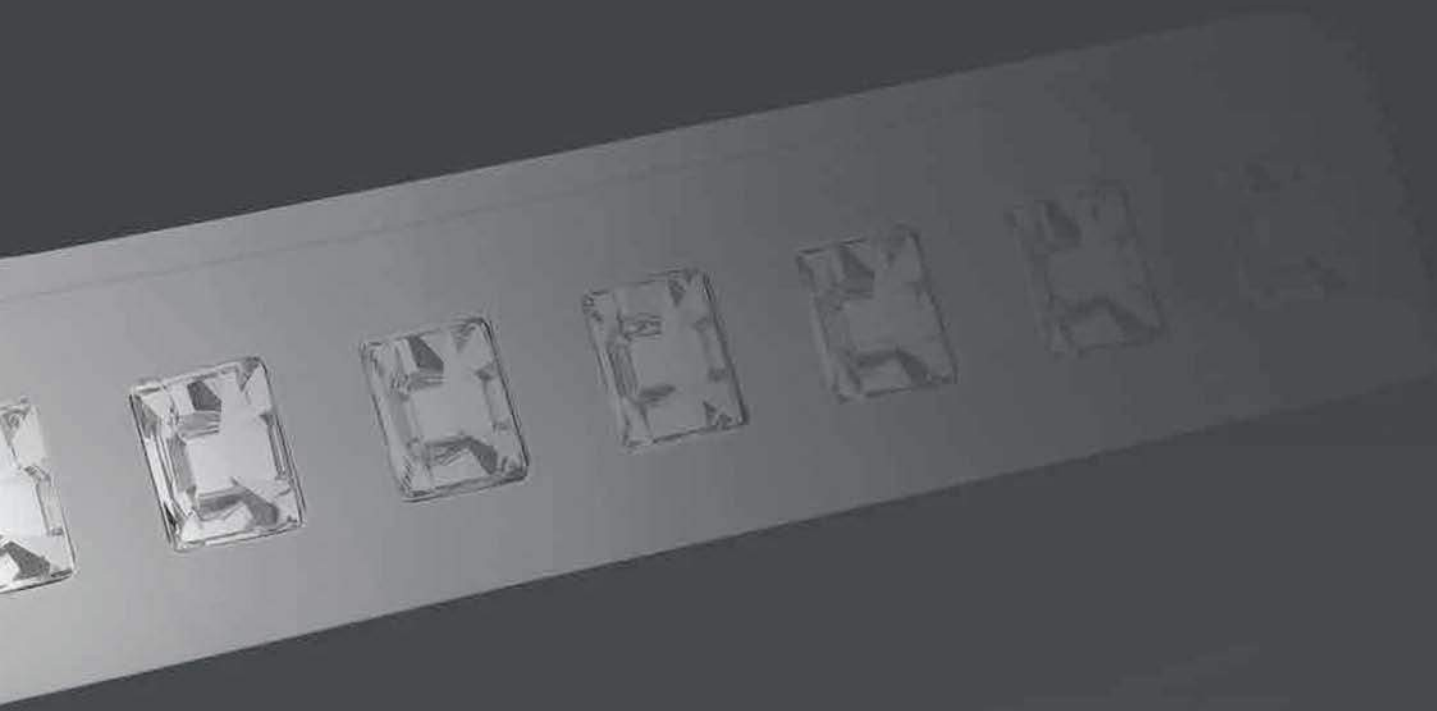

COLLECTION

Made with
**CRYSTAL
LIZ.FDY**
SWAROVSKI ELEMENTS

Finitura

OTL = OTTONE LUCIDO
 OSA = OTTONE SATINATO
 CRO = CROMATO
 CSA = CROMATO SATINATO
 NIS = NIKEL SATINATO
 NIN = NIKEL NERO

Finish

OTL = POLISHED BRASS
 OSA = SATIN BRASS
 CRO = CHROME PLATED
 CSA = SATIN CHROME
 NIS = SATIN NICKEL
 NIN = BLACK CHROME

Made with
**CRYSTAL
 LIZET**
 SWAROVSKI ELEMENTS



OTL



OSA



CRO



CSA



NIS



NIN



338€

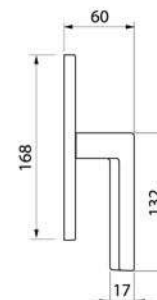
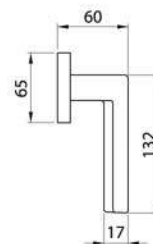
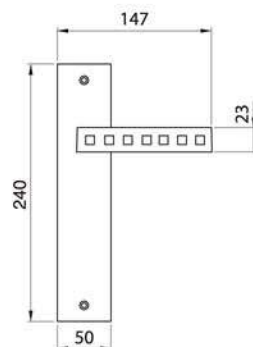
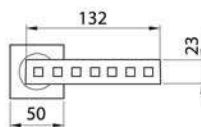

CULLINAN S1
 Maniglia su rosetta con bocchetta
 Door lever handle
 with rosette and escutcheon

CULLINAN PL
 Maniglia su rosetta placca
 Door lever handle with plate

CULLINAN W1
 Maniglia per finestra D.K.
 Window handle D.K.

CULLINAN W2
 Maniglia per finestra
 Window handle

CULLINAN®

Designer Mario Mazzer

Made with
**CRYSTAL
LIZED**
SWAROVSKI ELEMENTS



MORELLI®
MADE IN ITALY

Finitura

OTL = OTTONE LUCIDO
OSA = OTTONE SATINATO
CRO = CROMATO
CSA = CROMATO SATINATO
NIS = NIKEL SATINATO
NIN = NIKEL NERO

Finish

OTL = POLISHED BRASS
OSA = SATIN BRASS
CRO = CHROME PLATED
CSA = SATIN CHROME
NIS = SATIN NICKEL
NIN = BLACK CHROME

Made with
**CRYSTAL
LIZET**
SWAROVSKI ELEMENTS



OTL

OSA

CRO



CSA

NIS

NIN



270€

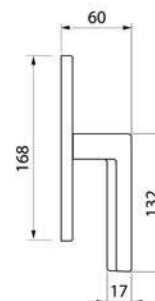
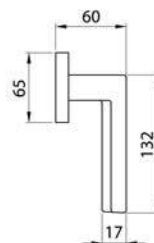
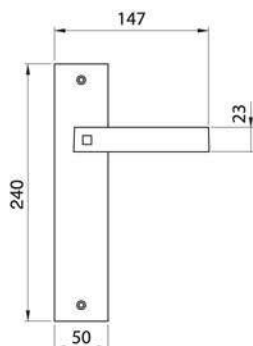
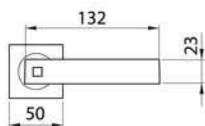

MOUNTAIN OF LIGHT S1
Maniglia su rosetta con bocchetta
Door lever handle
with rosette and escutcheon

MOUNTAIN OF LIGHT PL
Maniglia su rosetta placca
Door lever handle with plate

MOUNTAIN OF LIGHT W1
Maniglia per finestra D.K.
Window handle D.K.

MOUNTAIN OF LIGHT W2
Maniglia per finestra
Window handle

MOUNTAIN OF LIGHT®

Designer Mario Mazzer

Made with
**CRYSTAL
LIZED**
SWAROVSKI ELEMENTS



MORELLI®
MADE IN ITALY

Finitura

- OTL = OTTONE LUCIDO
- OSA = OTTONE SATINATO
- CRO = CROMATO
- CSA = CROMATO SATINATO
- NIS = NIKEL SATINATO
- NIN = NIKEL NERO

Finish

- OTL = POLISHED BRASS
- OSA = SATIN BRASS
- CRO = CHROME PLATED
- CSA = SATIN CHROME
- NIS = SATIN NICKEL
- NIN = BLACK CHROME

Made with
**CRYSTAL
LIZET**
SWAROVSKI ELEMENTS



OTL



OSA



CRO



CSA



NIS



NIN



254€

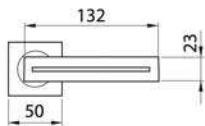

DIADEMA S1
Maniglia su rosetta con bocchetta
Door lever handle
with rosette and escutcheon

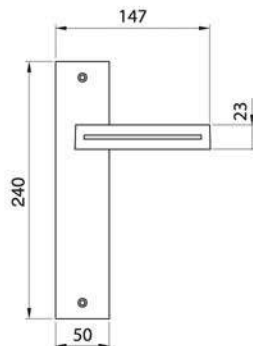

DIADEMA PL
Maniglia su rosetta placca
Door lever handle with plate

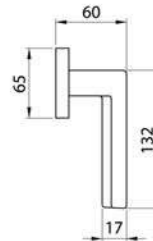

DIADEMA W1
Maniglia per finestra D.K.
Window handle D.K.

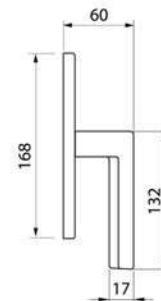

DIADEMA W2
Maniglia per finestra
Window handle

DIADEMA®

Designer Mario Mazzer

Made with
**CRYSTAL
LIZED**
SWAROVSKI ELEMENTS



MORELLI®
MADE IN ITALY

Finitura

- OTL = OTTONE LUCIDO
- OSA = OTTONE SATINATO
- CRO = CROMATO
- CSA = CROMATO SATINATO
- NIS = NIKEL SATINATO
- NIN = NIKEL NERO

Finish

- OTL = POLISHED BRASS
- OSA = SATIN BRASS
- CRO = CHROME PLATED
- CSA = SATIN CHROME
- NIS = SATIN NICKEL
- NIN = BLACK CHROME

Made with
**CRYSTAL
LIZET**
SWAROVSKI ELEMENTS



OTL

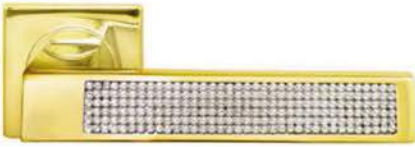

OSA



CRO



CSA



NIS



NIN



357€

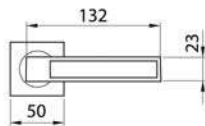

DDOLCE VITA S1
Maniglia su rosetta con bocchetta
Door lever handle
with rosette and escutcheon

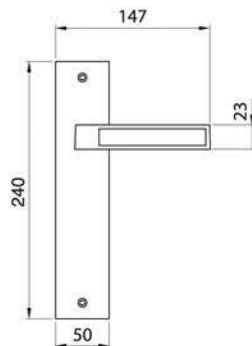

DDOLCE VITA PL
Maniglia su rosetta placca
Door lever handle with plate

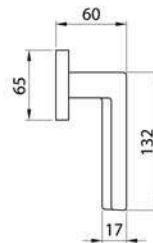

DDOLCE VITA W1
Maniglia per finestra D.K.
Window handle D.K.

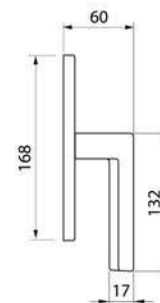

DDOLCE VITA W2
Maniglia per finestra
Window handle

DOLCE VITA®
Designer Mario Mazzer

Made with
**CRYSTAL
LIZED**
SWAROVSKI ELEMENTS



MORELLI®
MADE IN ITALY

Finitura

OTL = OTTONE LUCIDO
 CRO = CROMATO
 CSA = CROMATO SATINATO
 NIS = NIKEL SATINATO

Finish

OTL = POLISHED BRASS
 CRO = CHROME PLATED
 CSA = SATIN CHROME
 NIS = SATIN NICKEL

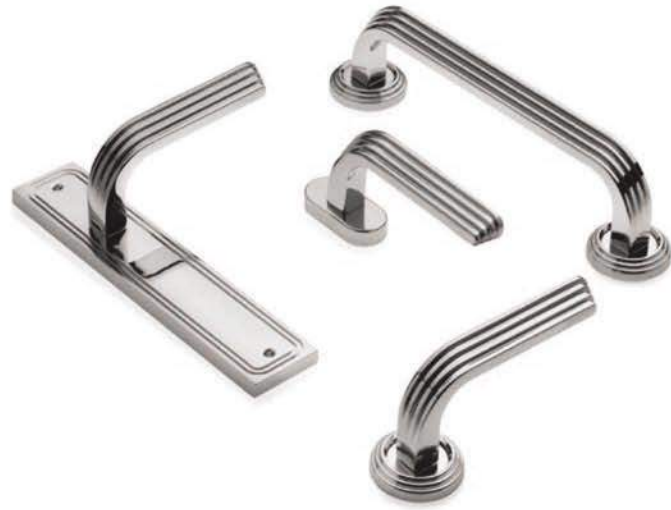

140 €

OTL



CRO



CSA



NIS



OTL



CRO



CSA

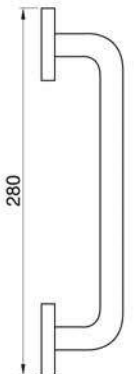
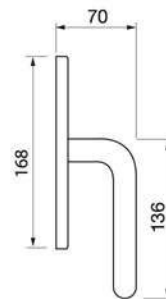
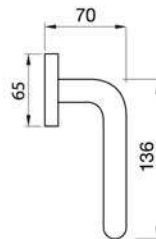
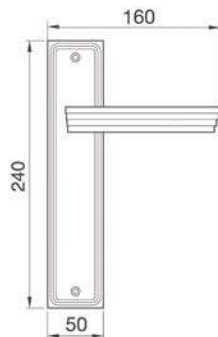
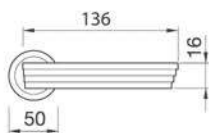
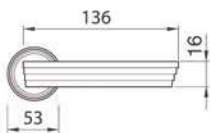

ALLURE WD
 Maniglia su rosetta con bocchetta
 Door lever handle
 with rosette and escutcheon

ALLURE R2
 Maniglia su rosetta con bocchetta
 Door lever handle
 with rosette and escutcheon

ALLURE PL
 Maniglia su rosetta placca
 Door lever handle with plate

ALLURE W1
 Maniglia per finestra D.K.
 Window handle D.K.

ALLURE W2
 Maniglia per finestra
 Window handle

ALLURE PH
 Maniglia
 Pull handle

ALLURE®

Designer Maurizio Giordano



MORELLI®
MADE IN ITALY

Finitura

- OTL = OTTONE LUCIDO
- OSA = OTTONE SATINATO
- CRO = CROMATO
- CSA = CROMATO SATINATO
- NIS = NIKEL SATINATO
- OBR = BRONZATO

Finish

- OTL = POLISHED BRASS
- OSA = SATIN BRASS
- CRO = CHROME PLATED
- CSA = SATIN CHROME
- NIS = SATIN NICKEL
- OBR = SATIN BRONZE



OTL



OSA



CRO



CSA



NIS



OBR



175 €

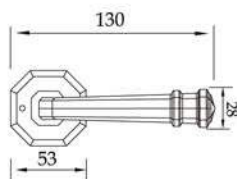

CHAMPS-ELISEES Y
Maniglia su rosetta con bocchetta
Door lever handle with rosette
and escutcheon

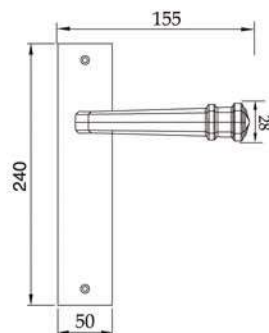

CHAMPS-ELISEES PL
Maniglia su rosetta placca
Door lever handle
with rosette and escutcheon

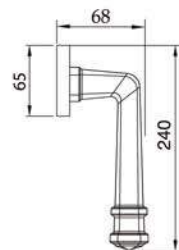

CHAMPS-ELISEES W1
Maniglia per finestra D.K.
Door lever handle with plate

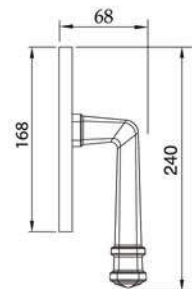

CHAMPS-ELISEES W2
Maniglia per finestra
Window handle D.K.

CHAMPS-ELISEES®

Design Studio Manital

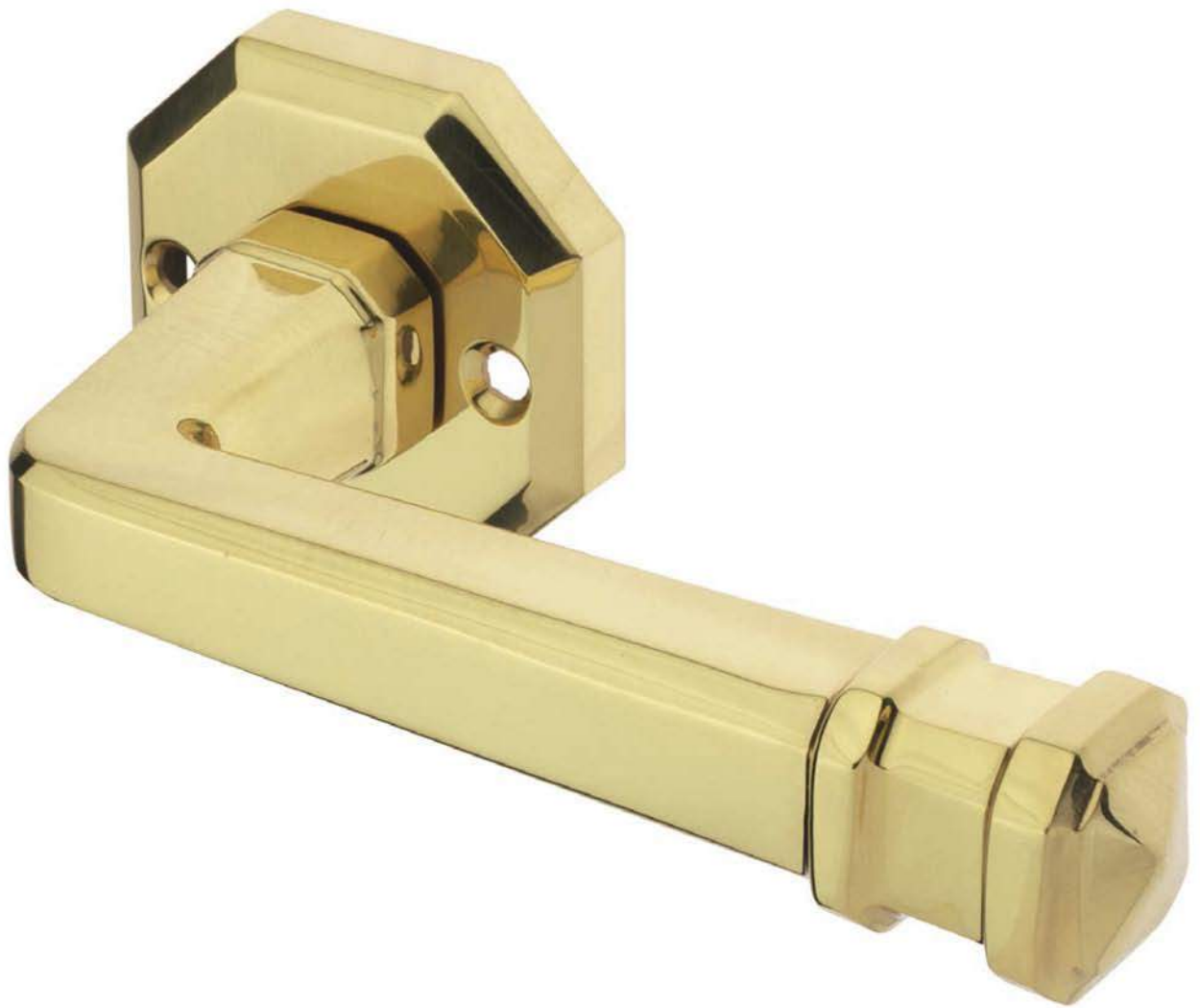

MORELLI®
MADE IN ITALY

Finitura

OTL = OTTONE LUCIDO
 OSA = OTTONE SATINATO
 CRO = CROMATO
 CSA = CROMATO SATINATO
 ? =
 ? =

Finish

OTL = POLISHED BRASS
 OSA = SATIN BRASS
 CRO = CHROME PLATED
 CSA = SATIN CHROME
 ? =
 ? =



189 €

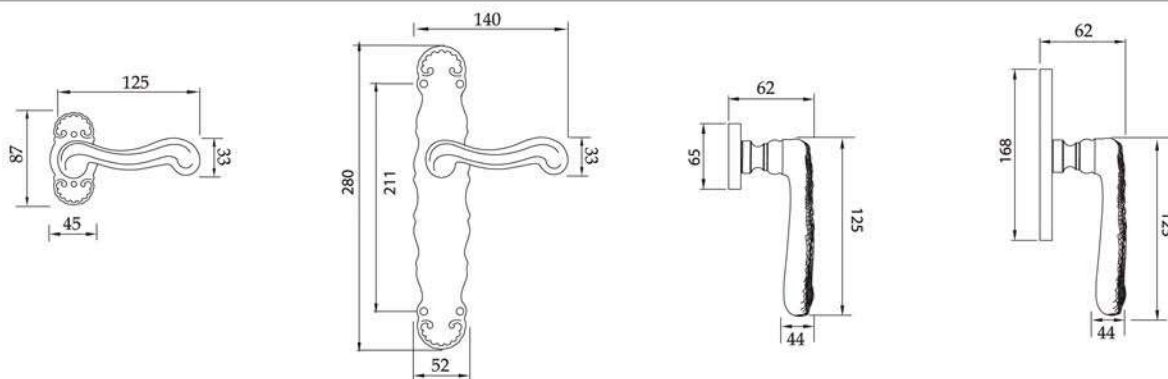

LOUVRE V
 Maniglia su rosetta con bocchetta
 Door lever handle
 with rosette and escutcheon

LOUVRE PL
 Maniglia su rosetta placca
 Door lever handle with plate

LOUVRE W1
 Maniglia per finestra D.K.
 Window handle D.K.

LOUVRE W2
 Maniglia per finestra
 Window handle

LOUVRE®

Design Studio Manital



MORELLI®
MADE IN ITALY



An aerial photograph of Earth from space, showing a coastline and a river. The top of the image is a dark, deep red gradient, likely representing the Earth's atmosphere or a specific light effect. Below this, a thin blue line marks the horizon of the Earth. The main part of the image is a high-angle aerial view of a coastal region. A prominent river flows from the bottom left towards the center, eventually meeting the sea. The land is a mix of brown, tan, and green, indicating different terrain types and vegetation. The water in the river and the sea is a deep blue. The overall composition is vertical, with the text overlaid on the right side.

NEW COLLECTION

SPACE

Finitura

CRO = CROMATO
 CSA = CROMATO SATINATO
 OBR = BRONZATO
 WHITE = CROMATO WHITE

Finish

CRO = CHROME PLATED
 CSA = SATIN CHROME
 OBR = SATIN BRONZE
 WHITE = WHITE



CRO

CSA

OBR



WHITE



44 €

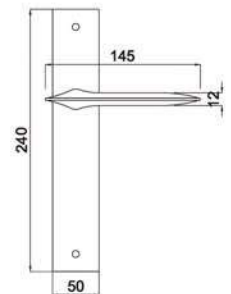
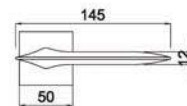
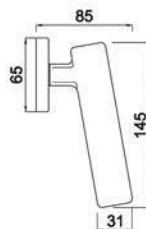
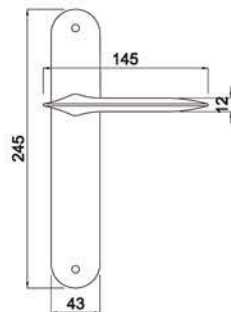
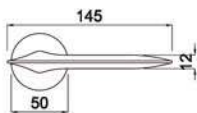

GALACTIC R2
 Maniglia su rosetta con bocchetta
 Door lever handle
 with rosette and escutcheon

GALACTIC PL 1
 Maniglia su rosetta placca
 Door lever handle with plate

GALACTIC W2
 Maniglia per finestra D.K.
 Window handle D.K.

GALACTIC S4
 Maniglia su rosetta con bocchetta
 Door lever handle
 with rosette and escutcheon

GALACTIC PL 2
 Maniglia su rosetta placca
 Door lever handle with plate

GALACTIC®

Designer Mario Mazzer



WINNER



MORELLI®
MADE IN ITALY

Finitura

CRO = CROMATO
 CSA = CROMATO SATINATO
 OBR = BRONZATO
 NIS = NIKEL SATINATO
 WHITE = CROMATO WHITE
 BLACK = CROMATO BLACK

Finish

CRO = CHROME PLATED
 CSA = SATIN CHROME
 OBR = SATIN BRONZE
 NIS = SATIN NICKEL
 WHITE = WHITE
 BLACK = BLACK



CRO

CSA

OBR



NIS

WHITE

BLACK



42 €

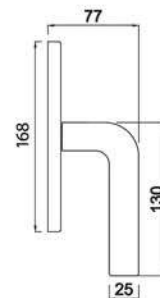
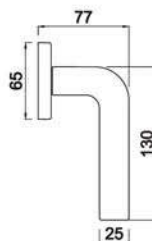
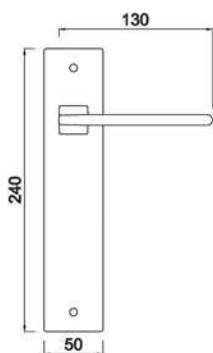
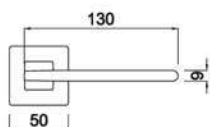

SPUTNIK S4
 Maniglia su rosetta con bocchetta
 Door lever handle
 with rosette and escutcheon

SPUTNIK PL
 Maniglia su rosetta placca
 Door lever handle with plate

SPUTNIK W1
 Maniglia per finestra D.K.
 Window handle D.K.

SPUTNIK W2
 Maniglia per finestra
 Window handle

SPUTNIK®

Designer Mario Mazzer

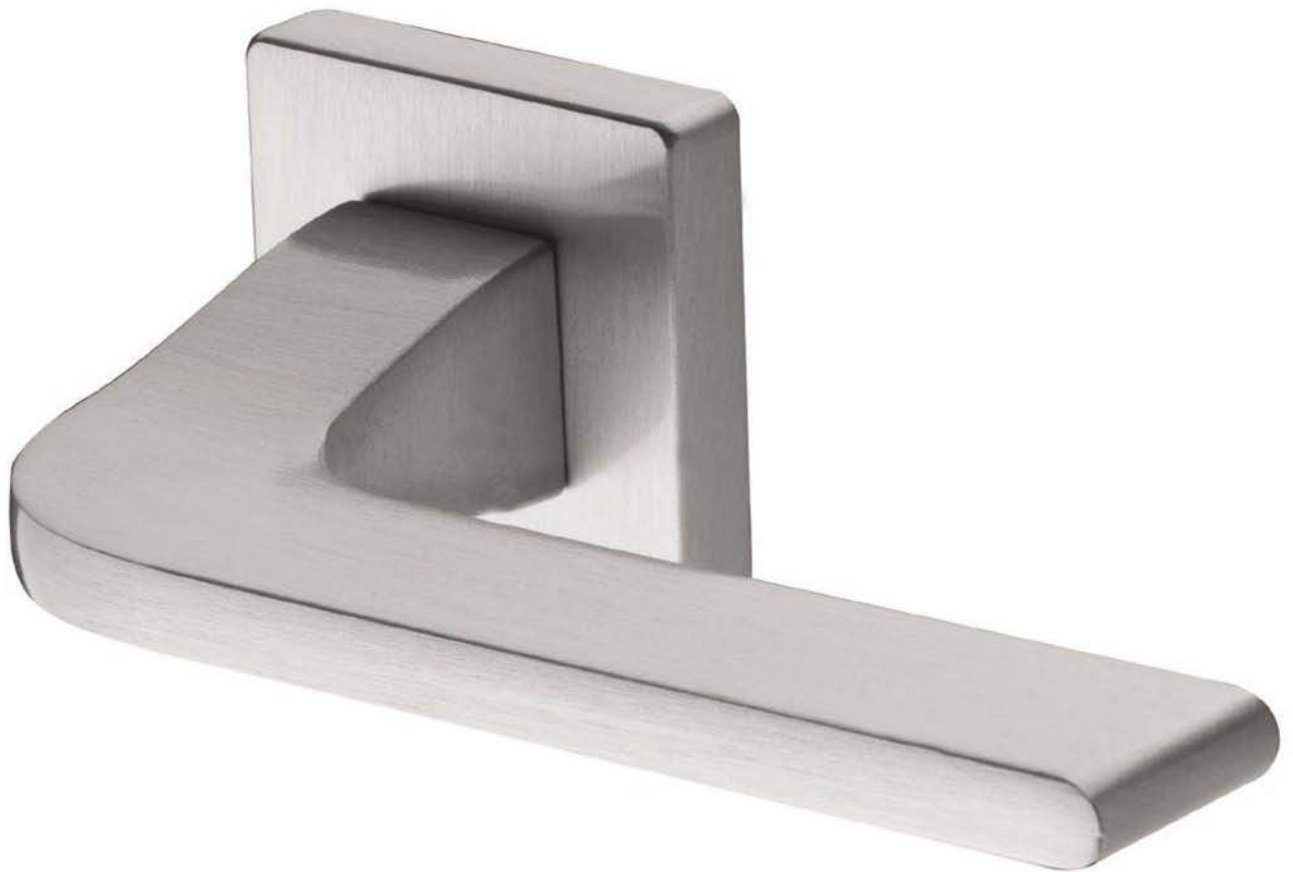

MORELLI®
MADE IN ITALY

Finitura

- CRO = CROMATO
- CSA = CROMATO SATINATO
- NIS = NIKEL SATINATO
- WHITE = CROMATO WHITE
- BLACK = CROMATO BLACK
- OBR = BRONZATO

Finish

- CRO = CHROME PLATED
- CSA = SATIN CHROME
- OBR = SATIN BRONZE
- NIS = SATIN NICKEL
- WHITE = WHITE
- BLACK = BLACK



CRO



CSA



NIS



WHITE



BLACK



OBR



40 €

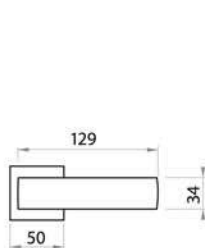

SPACE S4
Maniglia su rosetta con bocchetta
Door lever handle
with rosette and escutcheon

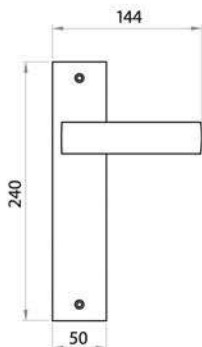

SPACE PL
Maniglia su rosetta placca
Door lever handle with plate

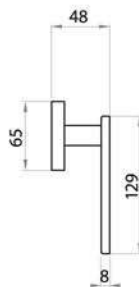

SPACE W1
Maniglia per finestra D.K.
Window handle D.K.

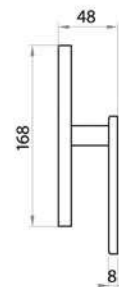

SPACE W2
Maniglia per finestra
Window handle

SPACE®

Designer Mario Mazzer



MORELLI®
MADE IN ITALY

Finitura

OTL = OTTONE LUCIDO
 CRO = CROMATO
 CSA = CROMATO SATINATO

Finish

OTL = POLISHED BRASS
 OSA = SATIN BRASS
 CRO = CHROME PLATED



CRO

CSA

CRO



CSA

CRO

CSA



40 €

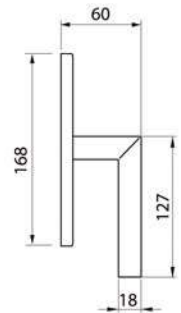
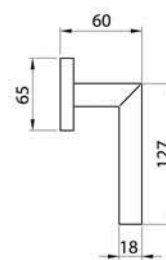
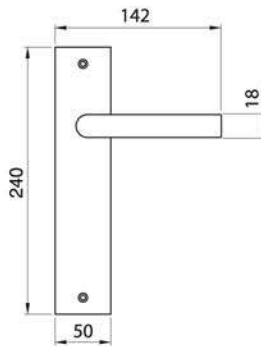
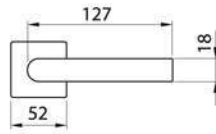
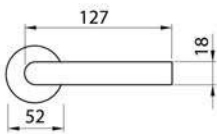

VOSTOK1 R1
 Maniglia su rosetta con bocchetta
 Door lever handle
 with rosette and escutcheon

VOSTOK1 S1
 Maniglia su rosetta con bocchetta
 Door lever handle
 with rosette and escutcheon

VOSTOK1 PL
 Maniglia su rosetta placca
 Door lever handle with plate

VOSTOK1 W1
 Maniglia per finestra D.K.
 Window handle D.K.

VOSTOK1 W2
 Maniglia per finestra
 Window handle

VOSTOK1®

Designer Mario Mazzer



MORELLI®
MADE IN ITALY





Finitura

OTL = OTTONE LUCIDO
 OSA = OTTONE SATINATO
 CRO = CROMATO
 CSA = CROMATO SATINATO
 NIS = NIKEL SATINATO
 OBR = BRONZATO

Finish

OTL = POLISHED BRASS
 OSA = SATIN BRASS
 CRO = CHROME PLATED
 CSA = SATIN CHROME
 NIS = SATIN NICKEL
 OBR = SATIN BRONZE



OTL

OSA

CRO

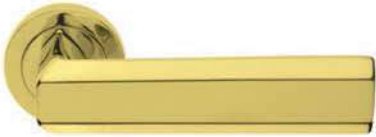

CSA

NIS

OBR



121 €

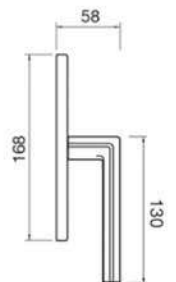
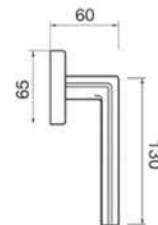
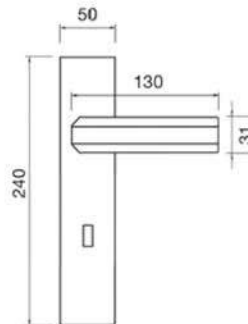
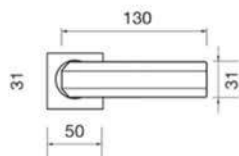
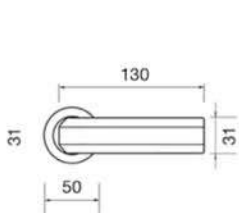

HARMONY R2
 Maniglia su rosetta con bocchetta
 Door lever handle
 with rosette and escutcheon

HARMONY S2
 Maniglia su rosetta con bocchetta
 Door lever handle
 with rosette and escutcheon

HARMONY PL
 Maniglia su rosetta placca
 Door lever handle with plate

HARMONY W1
 Maniglia per finestra D.K.
 Window handle D.K.

HARMONY W2
 Maniglia per finestra
 Window handle

HARMONY®

Designer Mario Mazzer



MORELLI®
MADE IN ITALY

Finitura

- OTL = OTTONE LUCIDO
- OSA = OTTONE SATINATO
- CRO = CROMATO
- CSA = CROMATO SATINATO
- NIS = NIKEL SATINATO
- OBR = BRONZATO

Finish

- OTL = POLISHED BRASS
- OSA = SATIN BRASS
- CRO = CHROME PLATED
- CSA = SATIN CHROME
- NIS = SATIN NICKEL
- OBR = SATIN BRONZE



OTL

OSA

CRO



CSA

NIS

OBR



132 €

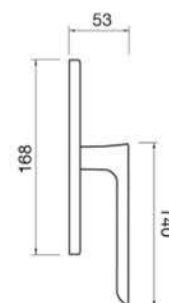
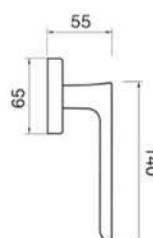
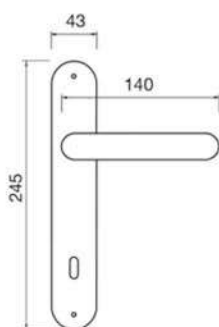
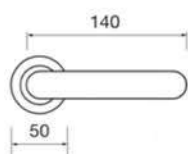

LE BOAT R2
Maniglia su rosetta con bocchetta
Door lever handle
with rosette and escutcheon

LE BOAT PL
Maniglia su rosetta placca
Door lever handle with plate

LE BOAT W1
Maniglia per finestra D.K.
Window handle D.K.

LE BOAT W2
Maniglia per finestra
Window handle

LE BOAT®

Designer Mario Mazzer e Giovanni Crosera



MORELLI®
MADE IN ITALY

Finitura

- OTL = OTTONE LUCIDO
- OSA = OTTONE SATINATO
- CRO = CROMATO
- CSA = CROMATO SATINATO
- NIS = NIKEL SATINATO
- OBR = BRONZATO

Finish

- OTL = POLISHED BRASS
- OSA = SATIN BRASS
- CRO = CHROME PLATED
- CSA = SATIN CHROME
- NIS = SATIN NICKEL
- OBR = SATIN BRONZE



OTL



OSA



CRO



CSA



NIS



OBR



97 €

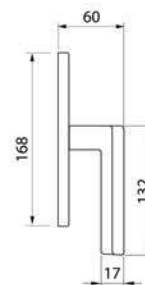
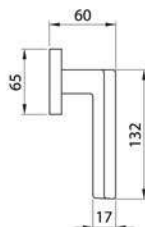
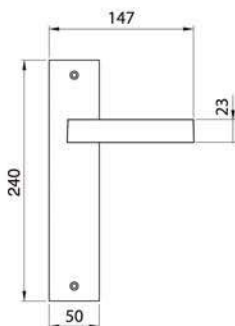
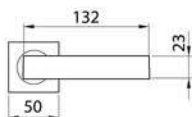

WATERFALL S2
Maniglia su rosetta con bocchetta
Door lever handle
with rosette and escutcheon

WATERFALL PL
Maniglia su rosetta placca
Door lever handle with plate

WATERFALL W1
Maniglia per finestra D.K.
Window handle D.K.

WATERFALL W2
Maniglia per finestra
Window handle

WATERFALL®

Designer Mario Mazzer



MORELLI®
MADE IN ITALY

Finitura

OTL = OTTONE LUCIDO
 CRO = CROMATO
 CSA = CROMATO SATINATO
 BIA = BIANCO
 NIS = NIKEL SATINATO
 NER = NERO

Finish

OTL = POLISHED BRASS
 CRO = CHROME PLATED
 CSA = SATIN CHROME
 BIA = WHITE
 NIS = SATIN NICKEL
 NER = BLACK

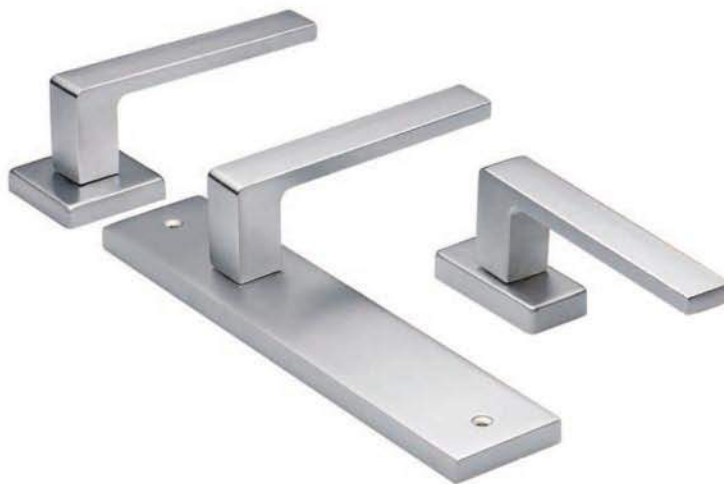

OTL

CRO

CSA



BIA

NIS

NER



35 €

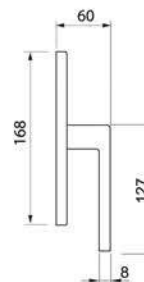
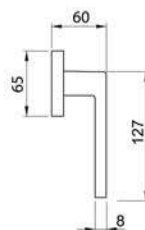
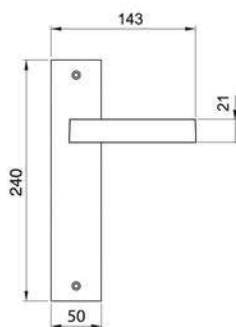
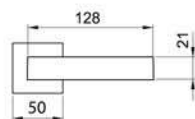

HORIZONTAL S4
 Maniglia su rosetta con bocchetta
 Door lever handle
 with rosette and escutcheon

HORIZONTAL PL
 Maniglia su rosetta placca
 Door lever handle with plate

HORIZONTAL W1
 Maniglia per finestra D.K.
 Window handle D.K.

HORIZONTAL W2
 Maniglia per finestra
 Window handle

HORIZONT®

Designer Mario Mazzer



MORELLI®
MADE IN ITALY

Finitura

- OTL = OTTONE LUCIDO
- CRO = CROMATO
- CSA = CROMATO SATINATO
- BIA = BIANCO
- NIS = NIKEL SATINATO
- NER = NERO

Finish

- OTL = POLISHED BRASS
- CRO = CHROME PLATED
- CSA = SATIN CHROME
- BIA = WHITE
- NIS = SATIN NICKEL
- NER = BLACK



OTL

CRO

CSA



BIA

NIS

NER



37 €

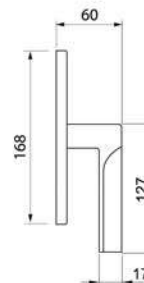
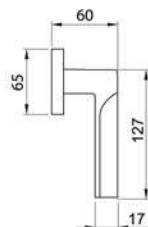
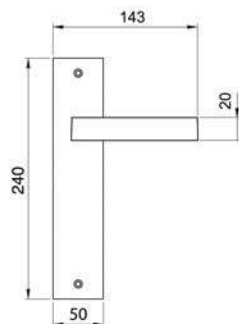
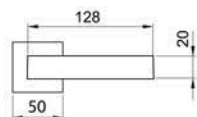

FIORD S4
Maniglia su rosetta con bocchetta
Door lever handle
with rosette and escutcheon

FIORD PL
Maniglia su rosetta placca
Door lever handle with plate

FIORD W1
Maniglia per finestra D.K.
Window handle D.K.

FIORD W2
Maniglia per finestra
Window handle

FIORD®

Designer Mario Mazzer



MORELLI®
MADE IN ITALY

Finitura

CRO = CROMATO
CSA = CROMATO SATINATO
OTL = OTTONE LUCIDO

Finish

OTL = POLISHED BRASS
CRO = CHROME PLATED
CSA = SATIN CHROME

MANCHESTER PLB OTL



LIVERPOOL PLB CRO



OXFORD PLB CSA



CAMBRIDGE PLB CSA

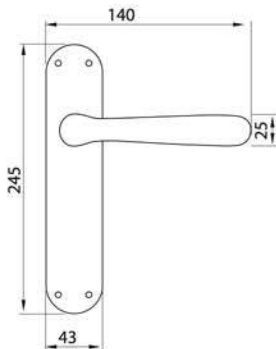

RUBINO PLB
Maniglia su placca
Door lever handle with plate

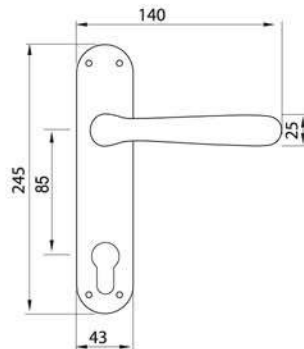

RUBINO PLB L85
Maniglia su rosetta placca
Door lever handle with plate

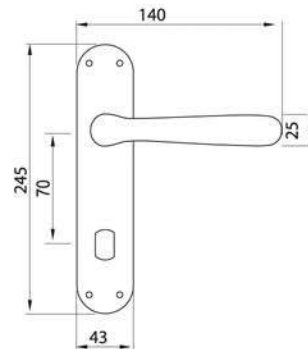

RUBINO PLB WC 70
Maniglia su WC placca
Door lever handle with plate

BRITISH STYLE

Design Studio Manital®



MORELLI®
MADE IN ITALY



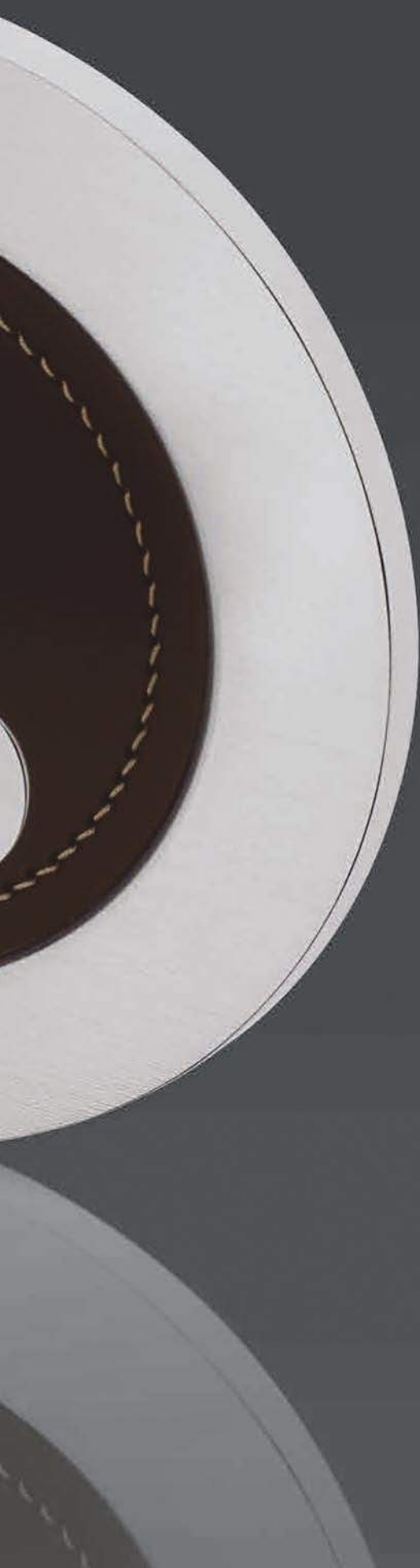

reddot
design award

Finitura

CSA = CROMATO SATINATO
 TESTA DI MORO = DARK BROWN
 CRO = CROMATO
 CUIOIO = LIGHT BROWN
 ANT = BLACK ANTHRACITE
 RAS = SATIN COPPER

Finish

CSA = SATIN CHROME
 TESTA DI MORO = DARK BROWN
 CRO = CHROME PLATED
 CUIOIO = LIGHT BROWN
 ANT = BLACK ANTHRACITE
 RAS = SATIN COPPER

BORDEAUX



ROSSO



BLU



BEIGE



AVORIO

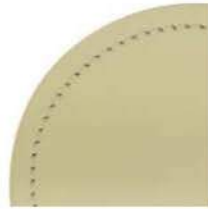

NERO



ARANCIONE



CSA / TESTA DI MORO



CSA / CRO



CRO / CSA



CRO / CUIOIO



ANT / TESTA DI MORO



ANT / RAS

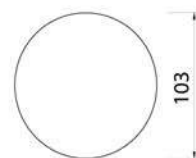
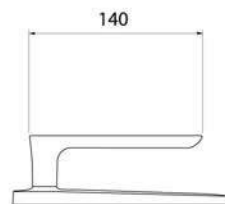
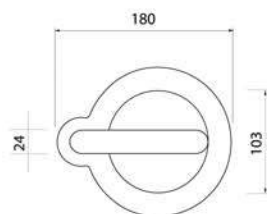
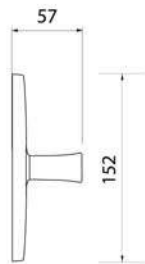

PLANET®

Designer Mario Mazzer e Giovanni Crosera



red dot
design award



MORELLI®
MADE IN ITALY

Finitura

OTL = OTTONE LUCIDO
CRO = CROMATO
CSA = CROMATO SATINATO
NIS = NIKEL SATINATO



Finish

OTL = POLISHED BRASS
CRO = CHROME PLATED
CSA = SATIN CHROME
NIS = SATIN NICKEL



OTL



CRO



CSA



NIS

85 €

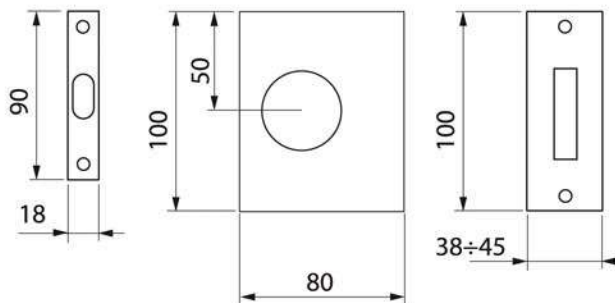

RAFT

Coppia placche incasso cieche con trascinatore
Sliding door rose, blind with flush pull

RAFT®

Designer Mario Mazzer



MORELLI®
MADE IN ITALY

Finitura

OTL = OTTONE LUCIDO
CRO = CROMATO
CSA = CROMATO SATINATO
NIS = NIKEL SATINATO

Finish

OTL = POLISHED BRASS
CRO = CHROME PLATED
CSA = SATIN CHROME
NIS = SATIN NICKEL



OTL



CRO



OSA



NIS

151 €

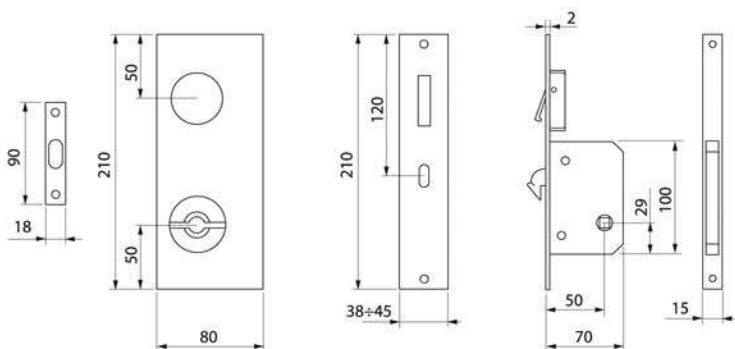

SIMPLE-S

Set seratura placa incasso con nottolino e trascinatore
Set of sliding door rose with wc turn, complete of flush pull and lock

SIMPLE-S®

Designer Mario Mazzer



MORELLI®
MADE IN ITALY

Finitura

- OTL = OTTONE LUCIDO
- OSA = OTTONE SATINATO
- OBR = BRONZATO
- CRO = CROMATO
- CSA = CROMATO SATINATO
- NIS = NIKEL SATINATO

Finish

- OTL = POLISHED BRASS
- OSA = SATIN BRASS
- OBR = SATIN BRONZE
- CRO = CHROME PLATED
- CSA = SATIN CHROME
- NIS = SATIN NICKEL

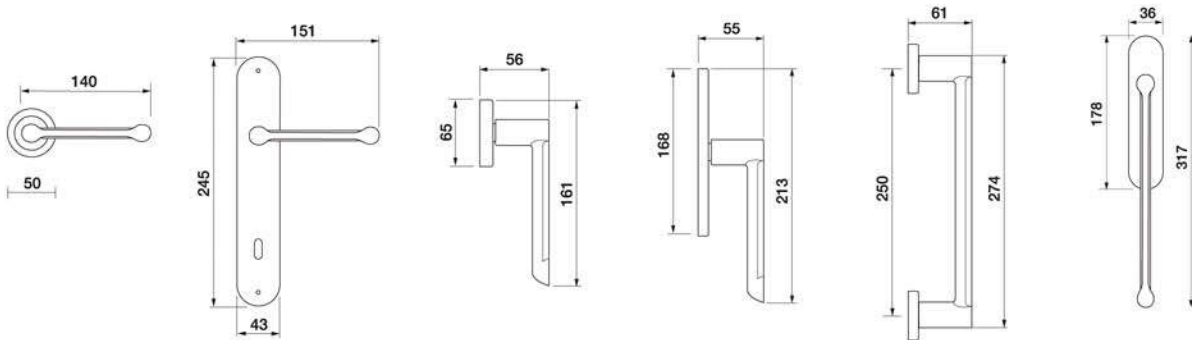

RAIN R2
Maniglia su rosetta con bocchetta
Door lever handle with rosette
and escutcheon

RAIN PL
Maniglia su rosetta placca
Door lever handle
with plate

RAIN W1
Maniglia per finestra D.K.
Window handle D.K.

RAIN W2
Maniglia per finestra
Window handle

RAIN PH
Pull handle

RAIN AS
Maniglione mm 250 con molla
meccanismo metallo
Single pull handle
on blank plate

RAIN®

Designer Mario Mazzer



WINNER OF
GOOD
DESIGN

MORELLI®
MADE IN ITALY

Finitura

- OTL = OTTONE LUCIDO
- OSA = OTTONE SATINATO
- OBR = BRONZATO
- CRO = CROMATO
- CSA = CROMATO SATINATO
- NIS = NIKEL SATINATO

Finish

- OTL = POLISHED BRASS
- OSA = SATIN BRASS
- OBR = SATIN BRONZE
- CRO = CHROME PLATED
- CSA = SATIN CHROME
- NIS = SATIN NICKEL



OTL

OSA

CRO



OBR

CSA

NIS



77 €

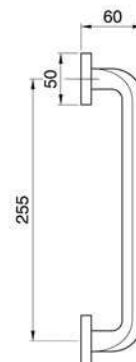
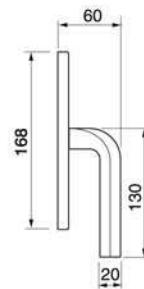
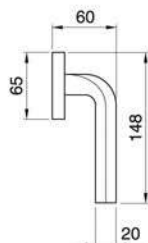
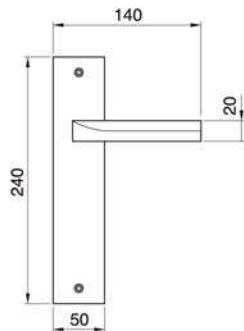
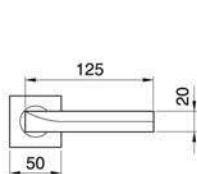

TENDER S3
Maniglia su rosetta con bocchetta
Door lever handle
with rosette and escutcheon

TENDER PL
Maniglia su rosetta placca
Door lever handle with plate

TENDER W1
Maniglia per finestra D.K.
Window handle D.K.

TENDER W2
Maniglia per finestra
Window handle

TENDER PH
Maniglia
Pull handle

TENDER®

Designer Paolo Pedrizzetti



MORELLI®
MADE IN ITALY

Finitura

OTL = OTTONE LUCIDO
 OSA = OTTONE SATINATO
 OBR = BRONZATO
 CRO = CROMATO
 CSA = CROMATO SATINATO
 NIS = NIKEL SATINATO

Finish

OTL = POLISHED BRASS
 OSA = SATIN BRASS
 OBR = SATIN BRONZE
 CRO = CHROME PLATED
 CSA = SATIN CHROME
 NIS = SATIN NICKEL



OTL

OSA

CRO



OBR

CSA

NIS



92 €

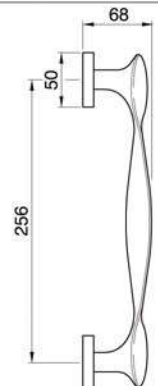
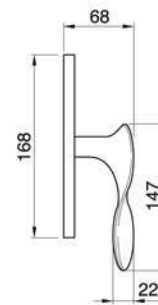
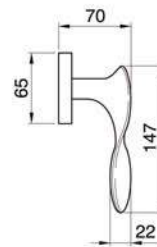
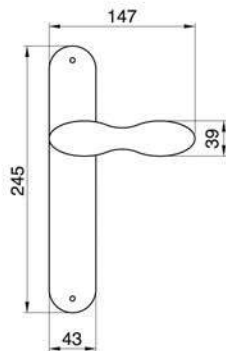
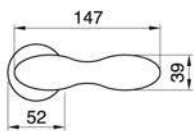

LUNCH PF
 Maniglia su rosetta con bocchetta
 Door lever handle
 with rosette and escutcheon

LUNCH PL
 Maniglia su rosetta placca
 Door lever handle with plate

LUNCH W1
 Maniglia per finestra D.K.
 Window handle D.K.

LUNCH W2
 Maniglia per finestra
 Window handle

LUNCH PH
 Maniglia
 Pull handle

LUNCH®

Designer Mario Mazzer



MORELLI®
MADE IN ITALY

Finitura

OTL = OTTONE LUCIDO
 OSA = OTTONE SATINATO
 OBR = BRONZATO
 CRO = CROMATO
 CSA = CROMATO SATINATO
 NIS = NIKEL SATINATO

Finish

OTL = POLISHED BRASS
 OSA = SATIN BRASS
 OBR = SATIN BRONZE
 CRO = CHROME PLATED
 CSA = SATIN CHROME
 NIS = SATIN NICKEL



OTL

OSA

CRO



OBR

CSA

NIS



90 €

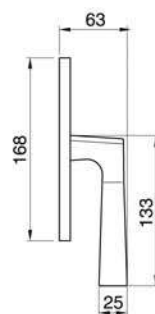
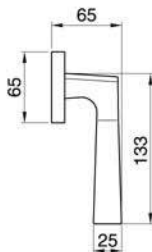
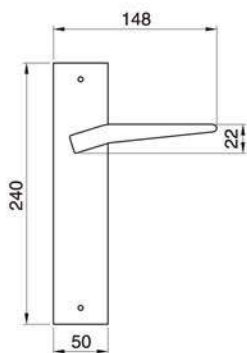
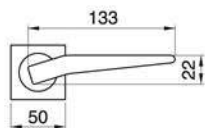

HILL S2
 Maniglia su rosetta con bocchetta
 Door lever handle
 with rosette and escutcheon

HILL PL
 Maniglia su rosetta placca
 Door lever handle with plate

HILL W1
 Maniglia per finestra D.K.
 Window handle D.K.

HILL W2
 Maniglia per finestra
 Window handle

HILL PH
 Maniglia
 Pull handle

HILL®

Designer Mario Mazzer



MORELLI®
MADE IN ITALY

Finitura

OTL = OTTONE LUCIDO
 OSA = OTTONE SATINATO
 OBR = BRONZATO
 CRO = CROMATO
 CSA = CROMATO SATINATO
 NIS = NIKEL SATINATO

Finish

OTL = POLISHED BRASS
 OSA = SATIN BRASS
 OBR = SATIN BRONZE
 CRO = CHROME PLATED
 CSA = SATIN CHROME
 NIS = SATIN NICKEL



87 €

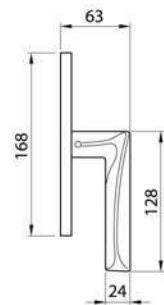
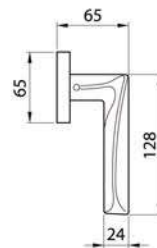
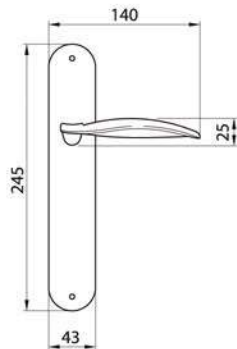
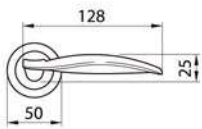

WAVE R2
 Maniglia su rosetta con bocchetta
 Door lever handle
 with rosette and escutcheon

WAVE PL
 Maniglia su rosetta placca
 Door lever handle with plate

WAVE W1
 Maniglia per finestra D.K.
 Window handle D.K.

WAVE W2
 Maniglia per finestra
 Window handle

WAVE®

Designer Maurizio Giordano e Roberto Grossi



MORELLI®
MADE IN ITALY

Finitura

OTL = OTTONE LUCIDO
 OSA = OTTONE SATINATO
 OBR = BRONZATO
 CRO = CROMATO
 CSA = CROMATO SATINATO
 NIS = NIKEL SATINATO

Finish

OTL = POLISHED BRASS
 OSA = SATIN BRASS
 OBR = SATIN BRONZE
 CRO = CHROME PLATED
 CSA = SATIN CHROME
 NIS = SATIN NICKEL



OTL



OSA



CRO



OBR



CSA



NIS

88 €

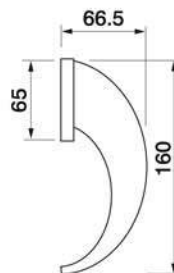
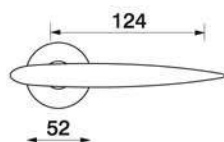

ABUNDANCE PF
 Maniglia su rosetta con bocchetta
 Door lever handle
 with rosette and escutcheon

ABUNDANCE W1
 Maniglia per finestra D.K.
 Window handle D.K.

ABUNDANCE®
Designer Itamar Harari



MORELLI®
MADE IN ITALY

Finitura

OTL = OTTONE LUCIDO
 OSA = OTTONE SATINATO
 OBR = BRONZATO
 CRO = CROMATO
 CSA = CROMATO SATINATO
 NIS = NIKEL SATINATO

Finish

OTL = POLISHED BRASS
 OSA = SATIN BRASS
 OBR = SATIN BRONZE
 CRO = CHROME PLATED
 CSA = SATIN CHROME
 NIS = SATIN NICKEL



83 €

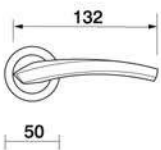

WIND R2
 Maniglia su rosetta con bocchetta
 Door lever handle
 with rosette and escutcheon

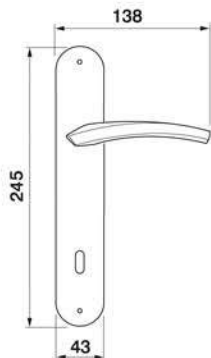

WIND PL
 Maniglia su rosetta placca
 Door lever handle with plate

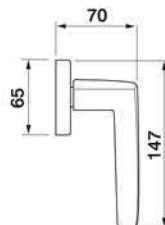

WIND W1
 Maniglia per finestra D.K.
 Window handle D.K.

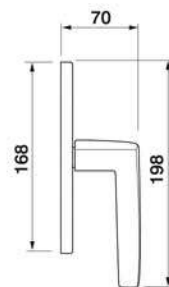

WIND W2
 Maniglia per finestra
 Window handle

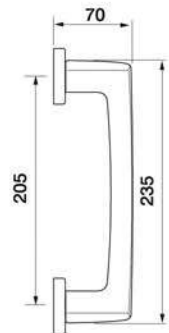

WIND PH
 Maniglia
 Pull handle

WIND®

Designer Maurizio Giordano e Roberto Grossi



MORELLI®
MADE IN ITALY

Finitura

OTL = OTTONE LUCIDO
 OSA = OTTONE SATINATO
 OBR = BRONZATO
 CRO = CROMATO
 CSA = CROMATO SATINATO
 NIS = NIKEL SATINATO

Finish

OTL = POLISHED BRASS
 OSA = SATIN BRASS
 OBR = SATIN BRONZE
 CRO = CHROME PLATED
 CSA = SATIN CHROME
 NIS = SATIN NICKEL



83 €

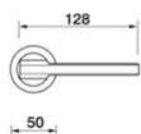

ROCK R2
 Maniglia su rosetta con bocchetta
 Door lever handle
 with rosette and escutcheon

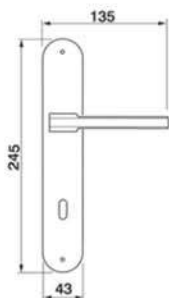

ROCK PL
 Maniglia su rosetta placca
 Door lever handle with plate

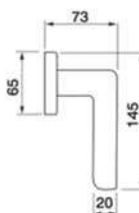

ROCK W1
 Maniglia per finestra D.K.
 Window handle D.K.

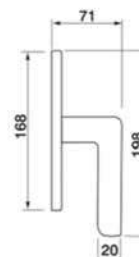

ROCK W2
 Maniglia per finestra
 Window handle

ROCK®

Designer Maurizio Giordano e Roberto Grossi



MORELLI®
MADE IN ITALY

Finitura

OTL = OTTONE LUCIDO
 OSA/OTL = OTT. SAT./OTT. LUC.
 CRO = CROMATO
 NIS/NIK = NIKEL SAT./NIKEL
 CSA/CRO = CRO. SAT./CROM.
 CSA = CROMATO SATINATO

Finish

OTL = POLISHED BRASS
 OSA/OTL = SAT. BRASS/POL. BRASS
 CRO = CHROME PLATED
 NIS/NIK = SAT. NICKEL/NICKEL
 CSA/CRO = SAT. CHR./CHR. PLATED
 CSA = SATIN CHROME



81 €

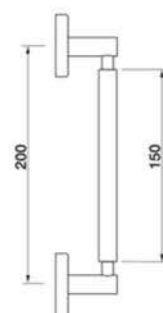
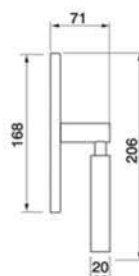
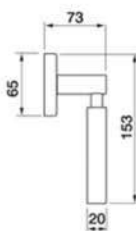
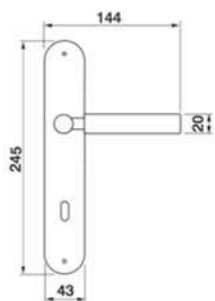
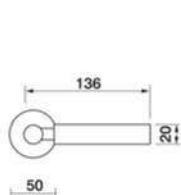

CLOUD R3
 Maniglia su rosetta con bocchetta
 Door lever handle
 with rosette and escutcheon

CLOUD PL
 Maniglia su rosetta placca
 Door lever handle with plate

CLOUD W1
 Maniglia per finestra D.K.
 Window handle D.K.

CLOUD W2
 Maniglia per finestra
 Window handle

CLOUD PH
 Maniglia
 Pull handle

CLOUD®

Designer Sottsass Associati



MORELLI®
MADE IN ITALY

Finitura

- OTL = OTTONE LUCIDO
- OSA = OTTONE SATINATO
- OBR = BRONZATO
- CRO = CROMATO
- CSA = CROMATO SATINATO
- NNK = NIKEL NERO / ORO 24K
- NIS = NIKEL SATINATO
- NIN = NIKEL NERO

Finish

- OTL = POLISHED BRASS
- OSA = SATIN BRASS
- OBR = SATIN BRONZE
- CRO = CHROME PLATED
- CSA = SATIN CHROME
- NNK = BLACK CHROME / GOLD 24K
- NIS = SATIN NICKEL
- NIN = BLACK CHROME

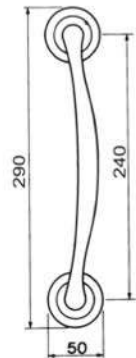
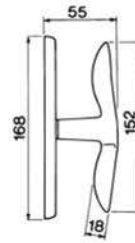
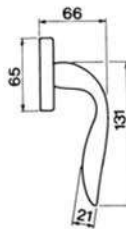
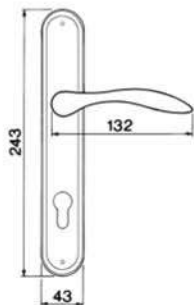
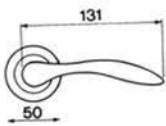

LEON R2
Maniglia su rosetta con bocchetta
Door lever handle
with rosette and escutcheon

LEON PL
Maniglia su rosetta placca
Door lever handle with plate

LEON W1
Maniglia per finestra D.K.
Window handle D.K.

LEON W2
Maniglia per finestra
Window handle

LEON PH
Maniglia
Pull handle

LEON®

Designer Maurizio Giordano e Roberto Grossi



MORELLI®
MADE IN ITALY

Finitura

- OTL = OTTONE LUCIDO
- CRO = CROMATO
- CSA/CRO = CROM. SAT./CROM.
- OSA/OTL = OTT. SAT./OTT. LUC.
- NIS/NIK = NIKEL SAT./NIKEL
- COT = CROMATO/OTTONE LUC.

Finish

- OTL = POLISHED BRASS
- CRO = CHROME PLATED
- CSA/CRO = SAT. CHR./CHR. PLATED
- OSA/OTL = SAT. BRASS/POL. BRASS
- NIS/NIK = SAT. NICKEL/NICKEL
- COT = CHR. PLATED/POL. BRASS



OTL



OSA / OTL



OTL



CRO



NIS / NIK



OTL



CSA/CRO



COT

90

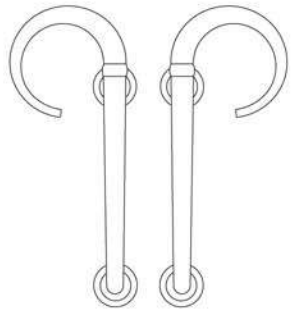
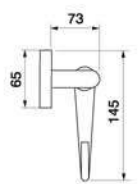
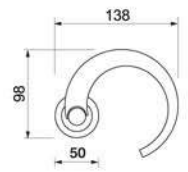
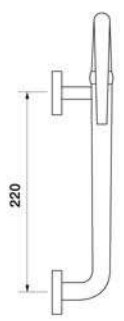
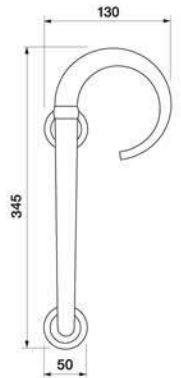

LANGOUST PH R
Maniglia
Pull handle right hand

LANGOUST PH L
Maniglia
Pull handle left hand

LANGOUST R2
Maniglia su rosetta con bocchetta
Door lever handle
with rosettes and escutcheon

LANGOUST W1
Maniglia per finestra D.K.
Window handle D.K.

LANGOUST PH
Maniglia
Pull handle back to back

LANGOUST®

Designer Mauro Artusio



MORELLI®
MADE IN ITALY

Finitura

OTL = OTTONE LUCIDO
 OSA = OTTONE SATINATO
 OBR = BRONZATO
 CRO = CROMATO
 CSA = CROMATO SATINATO
 NIS = NIKEL SATINATO
 NIN = NIKEL NERO

Finish

OTL = POLISHED BRASS
 OSA = SATIN BRASS
 OBR = SATIN BRONZE
 CRO = CHROME PLATED
 CSA = SATIN CHROME
 NIS = SATIN NICKEL
 NIN = BLACK CHROME



92 €

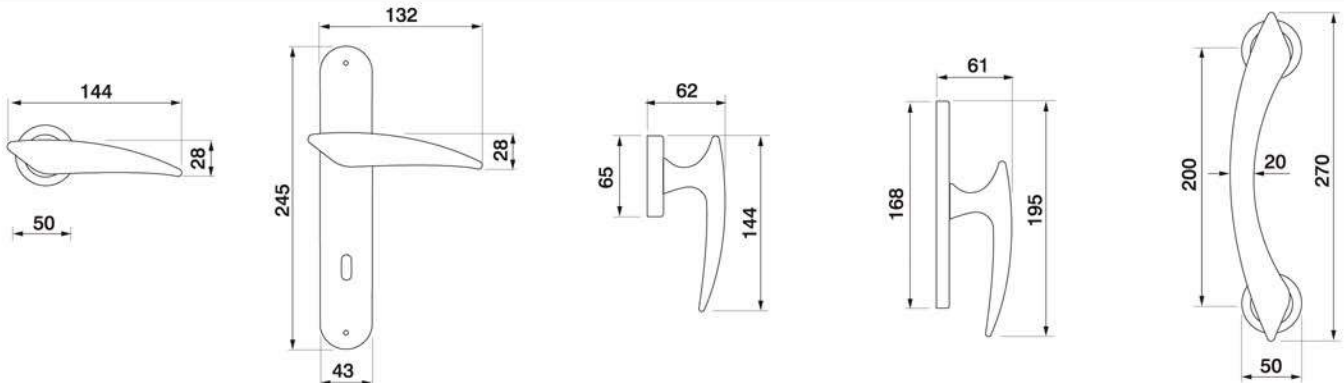

BOLID R2
 Maniglia su rosetta con bocchetta
 Door lever handle
 with rosette and escutcheon

BOLID PL
 Maniglia su rosetta placca
 Door lever handle with plate

BOLID W1
 Maniglia per finestra D.K.
 Window handle D.K.

BOLID W2
 Maniglia per finestra
 Window handle

BOLID PH
 Maniglia
 Pull handle

BOLID®

Designer Pedrizzetti & Associati



MORELLI®
MADE IN ITALY

Finitura

- OTL = OTTONE LUCIDO
- OSA = OTTONE SATINATO
- OBR = BRONZATO
- CRO = CROMATO
- CSA = CROMATO SATINATO
- NIS = NIKEL SATINATO

Finish

- OTL = POLISHED BRASS
- OSA = SATIN BRASS
- OBR = SATIN BRONZE
- CRO = CHROME PLATED
- CSA = SATIN CHROME
- NIS = SATIN NICKEL



OTL



OSA



CRO



OBR



CSA



NIS

72 €

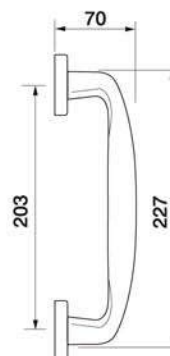
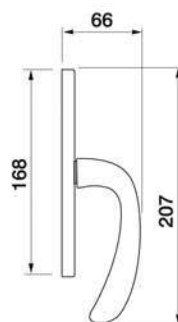
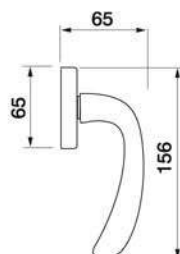
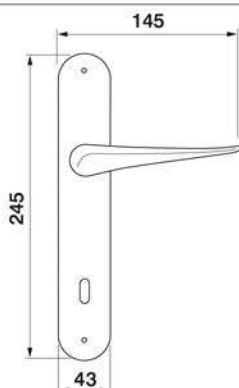
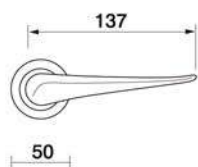

GOLF R4
Maniglia su rosetta con bocchetta
Door lever handle
with rosette and escutcheon

GOLF PL
Maniglia su rosetta placca
Door lever handle with plate

GOLF W1
Maniglia per finestra D.K.
Window handle D.K.

GOLF W2
Maniglia per finestra
Window handle

GOLF PH
Maniglia
Pull handle

GOLF®

Designer Dario Grasselli e Paolo Pedrizzetti



MORELLI®
MADE IN ITALY

Finitura

- OTL = OTTONE LUCIDO
- OSA = OTTONE SATINATO
- OSA/OTL = OTT. SAT./OTT. LUC.
- CRO = CROMATO
- CSA = CROMATO SATINATO
- NIS/NIK = NIKEL SAT./NIKEL
- NIN = NIKEL NERO

Finish

- OTL = POLISHED BRASS
- OSA = SATIN BRASS
- OSA/OTL = SAT. BRASS/POL. BRASS
- CRO = CHROME PLATED
- CSA = SATIN CHROME
- NIS/NIK = SAT. NICKEL/NICKEL
- NIN = BLACK CHROME



92 €

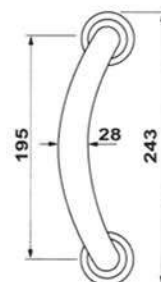
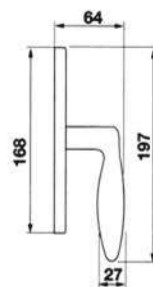
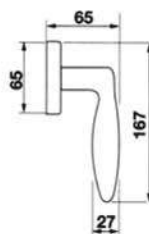
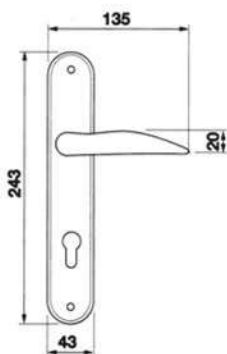
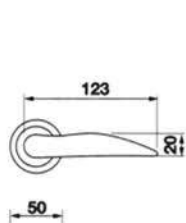

DALI R2
Maniglia su rosetta con bocchetta
Door lever handle
with rosette and escutcheon

DALI PL
Maniglia su rosetta placca
Door lever handle with plate

DALI W1
Maniglia per finestra D.K.
Window handle D.K.

DALI W2
Maniglia per finestra
Window handle

DALI PH
Maniglia
Pull handle

DALÌ®

Designer Titi Cusatelli



MORELLI®
MADE IN ITALY

Finitura

- OTL = OTTONE LUCIDO
- OSA/OTL = OTT. SAT./OTT. LUC.
- CRO = CROMATO
- CSA = CROMATO SATINATO
- NIS/NIK = NIKEL SAT./NIKEL
- NIN = NIKEL NERO
- CSA/CRO = CROM. SAT./CROM.

Finish

- OTL = POLISHED BRASS
- OSA/OTL = SAT. BRASS/POL. BRASS
- CRO = CHROME PLATED
- CSA = SATIN CHROME
- NIS/NIK = SAT. NICKEL/NICKEL
- NIN = BLACK CHROME
- CSA/CRO = SAT. CHR./CHR. PLATED



83 €

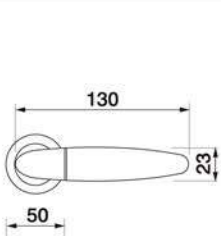

SAIL R2
Maniglia su rosetta con bocchetta
Door lever handle
with rosette and escutcheon

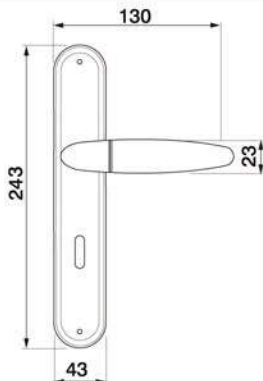

SAIL PL
Maniglia su rosetta placca
Door lever handle with plate

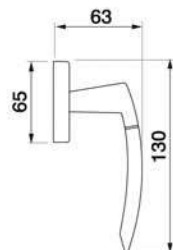

SAIL W1
Maniglia per finestra D.K.
Window handle D.K.

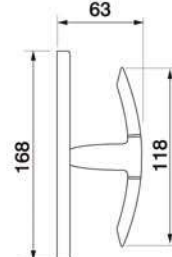

SAIL W2
Maniglia per finestra
Window handle

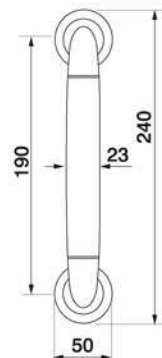

SAIL PH
Maniglia
Pull handle

SAIL®

Designer Maurizio Giordano e Roberto Grossi



MORELLI®
MADE IN ITALY

Finitura

OTL = OTTONE LUCIDO
 OSA = OTTONE SATINATO
 CRO = CROMATO
 CSA = CROMATO SATINATO
 NIS = NIKEL SATINATO
 NIN = NIKEL NERO

Finish

OTL = POLISHED BRASS
 OSA = SATIN BRASS
 CRO = CHROME PLATED
 CSA = SATIN CHROME
 NIS = SATIN NICKEL
 NIN = BLACK CHROME



OTL



OSA



CRO



NIN



CSA



NIS



67 €

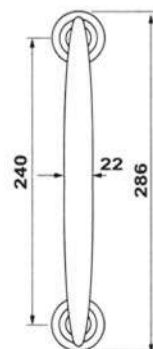
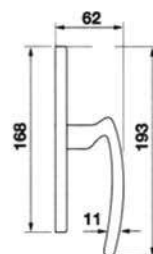
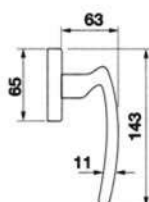
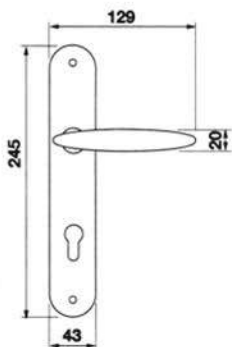
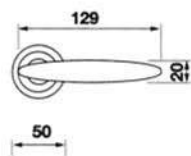

FLAMINGO R2
 Maniglia su rosetta con bocchetta
 Door lever handle
 with rosette and escutcheon

FLAMINGO PL
 Maniglia su rosetta placca
 Door lever handle with plate

FLAMINGO W1
 Maniglia per finestra D.K.
 Window handle D.K.

FLAMINGO W2
 Maniglia per finestra
 Window handle

FLAMINGO PH
 Maniglia
 Pull handle

FLAMINGO®

Designer Davide Mercatali



MORELLI®
MADE IN ITALY

Finitura

- OTL = OTTONE LUCIDO
- OSA = OTTONE SATINATO
- OSA/OTL = OTT. SAT./OTT. LUC.
- CRO = CROMATO
- CSA = CROMATO SATINATO
- NIS/NIK = NIKEL SAT./NIKEL
- NIN = NIKEL NERO

Finish

- OTL = POLISHED BRASS
- OSA = SATIN BRASS
- OSA/OTL = SAT. BRASS/POL. BRASS
- CRO = CHROME PLATED
- CSA = SATIN CHROME
- NIS/NIK = SAT. NICKEL/NICKEL
- NIN = BLACK CHROME



78 €

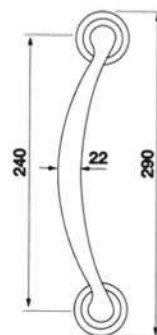
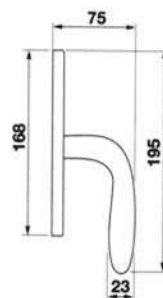
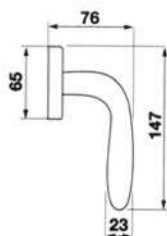
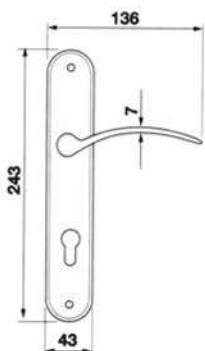
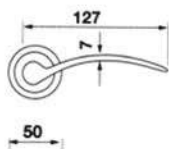

COBRA R2
Maniglia su rosetta con bocchetta
Door lever handle
with rosette and escutcheon

COBRA PL
Maniglia su rosetta placca
Door lever handle with plate

COBRA W1
Maniglia per finestra D.K.
Window handle D.K.

COBRA W2
Maniglia per finestra
Window handle

COBRA PH
Maniglia
Pull handle

COBRA®

Designer Maurizio Giordano e Roberto Grossi



MORELLI®
MADE IN ITALY

Finitura

OTL = OTTONE LUCIDO
 OSA = OTTONE SATINATO
 OBR = BRONZATO
 CRO = CROMATO
 CSA = CROMATO SATINATO
 NIS = NIKEL SATINATO

Finish

OTL = POLISHED BRASS
 OSA = SATIN BRASS
 OBR = SATIN BRONZE
 CRO = CHROME PLATED
 CSA = SATIN CHROME
 NIS = SATIN NICKEL



63 €

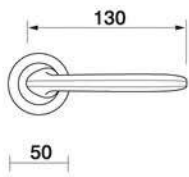

SAND R2
 Maniglia su rosetta con bocchetta
 Door lever handle with rosette and escutcheon

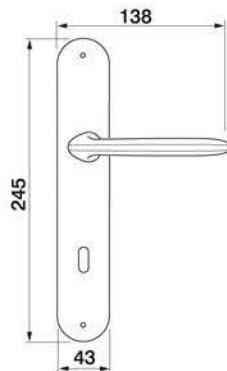

SAND PL
 Maniglia su rosetta placca
 Door lever handle with plate

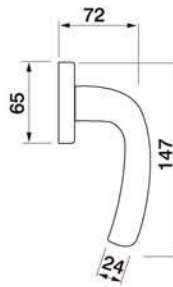

SAND W1
 Maniglia per finestra D.K.
 Window handle D.K.

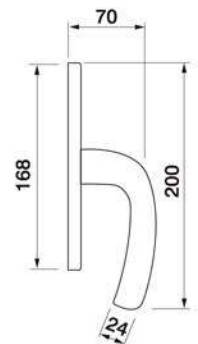

SAND W2
 Maniglia per finestra
 Window handle

SAND®

Design Studio Manital



MORELLI®
MADE IN ITALY

Finitura

OTL = OTTONE LUCIDO
 OSA = OTTONE SATINATO
 OBR = BRONZATO
 CRO = CROMATO
 CSA = CROMATO SATINATO
 NIS = NIKEL SATINATO

Finish

OTL = POLISHED BRASS
 OSA = SATIN BRASS
 OBR = SATIN BRONZE
 CRO = CHROME PLATED
 CSA = SATIN CHROME
 NIS = SATIN NICKEL

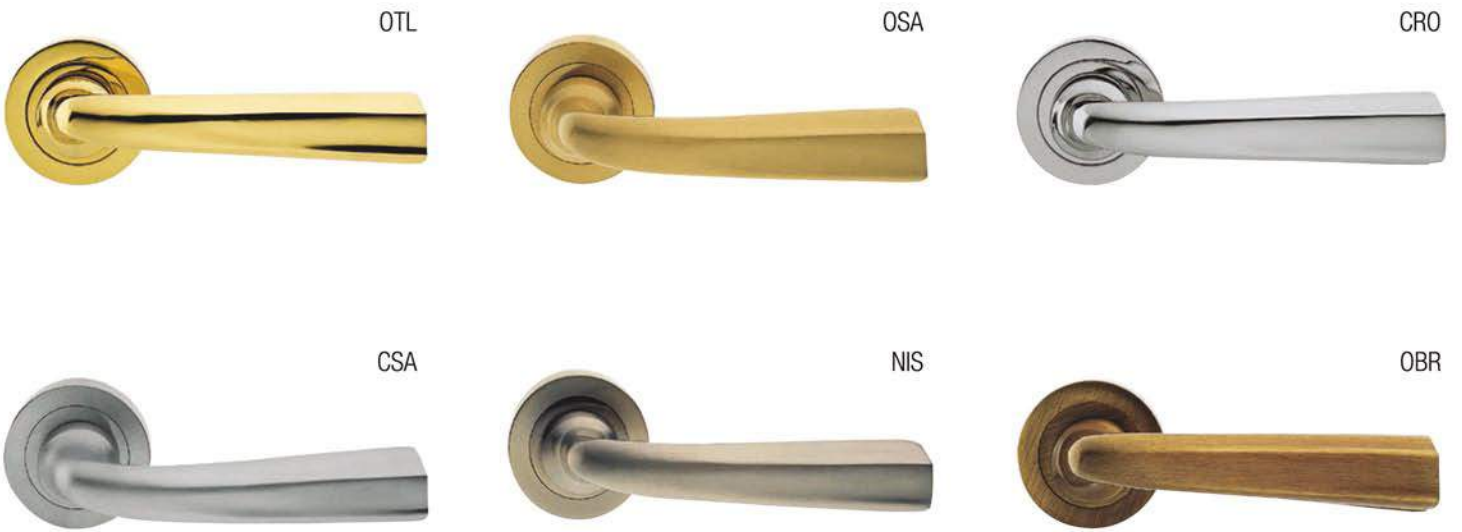

73 €

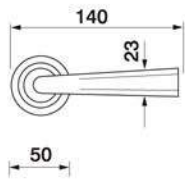

DREAM R2
 Maniglia su rosetta con bocchetta
 Door lever handle with rosette and escutcheon

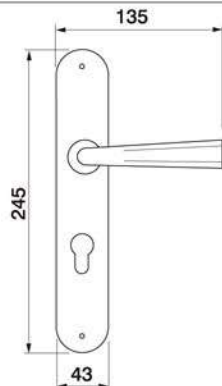

DREAM PL
 Maniglia su rosetta placca
 Door lever handle with plate

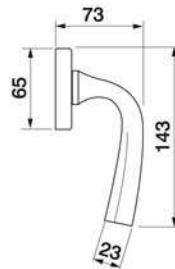

DREAM W1
 Maniglia per finestra D.K.
 Window handle D.K.

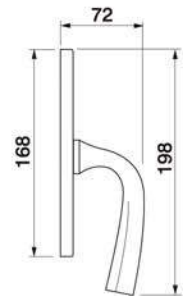

DREAM W2
 Maniglia per finestra
 Window handle

DREAM®

Designer Maurizio Giordano e Roberto Grossi



MORELLI®
MADE IN ITALY

Finitura

OTL = OTTONE LUCIDO
 OSA = OTTONE SATINATO
 OBR = BRONZATO
 CRO = CROMATO
 CSA = CROMATO SATINATO
 NIS = NIKEL SATINATO

Finish

OTL = POLISHED BRASS
 OSA = SATIN BRASS
 OBR = SATIN BRONZE
 CRO = CHROME PLATED
 CSA = SATIN CHROME
 NIS = SATIN NICKEL



OTL



OSA



CRO



CSA



NIS



OBR

62 €

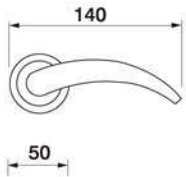

ARCH R4

Maniglia su rosetta con bocchetta
 Door lever handle with rosette and escutcheon

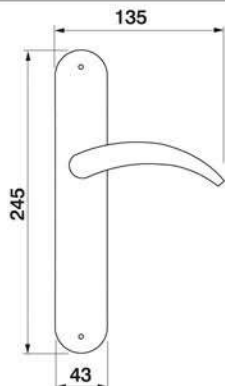

ARCH PL

Maniglia su rosetta placca
 Door lever handle with plate

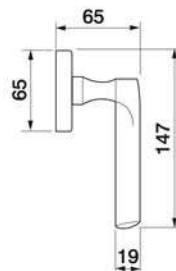

ARCH W1

Maniglia per finestra D.K.
 Window handle D.K.

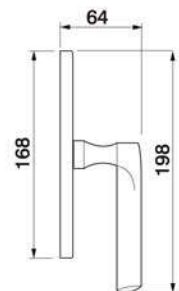

ARCH W2

Maniglia per finestra
 Window handle

ARCH[®]

Design Studio Manital



MORELLI[®]
MADE IN ITALY

Finitura

- OTL = OTTONE LUCIDO
- OSA = OTTONE SATINATO
- OBR = BRONZATO
- CRO = CROMATO
- CSA = CROMATO SATINATO
- NIS = NIKEL SATINATO

Finish

- OTL = POLISHED BRASS
- OSA = SATIN BRASS
- OBR = SATIN BRONZE
- CRO = CHROME PLATED
- CSA = SATIN CHROME
- NIS = SATIN NICKEL



OTL



OSA



CRO



OBR



CSA



NIS



73 €

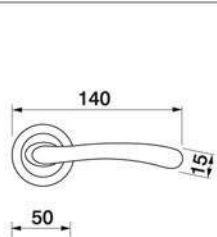

COCKATTO R2
Maniglia su rosetta con bocchetta
Door lever handle
with rosette and escutcheon

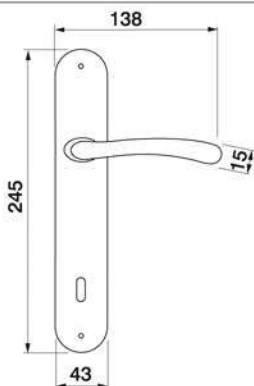

COCKATTO PL
Maniglia su rosetta placca
Door lever handle with plate

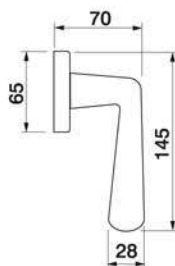

COCKATTO W1
Maniglia per finestra D.K.
Window handle D.K.

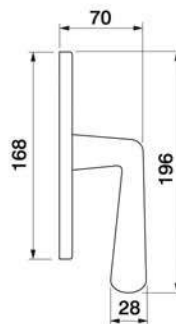

COCKATTO W2
Maniglia per finestra
Window handle

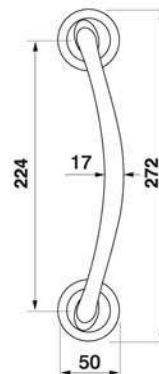

COCKATTO PH
Maniglia
Pull handle

COCKATOO®

Designer Pedrizzetti & Associati



MORELLI®
MADE IN ITALY

Finitura

OTL = OTTONE LUCIDO
 OSA = OTTONE SATINATO
 OBR = BRONZATO
 CRO = CROMATO
 CSA = CROMATO SATINATO
 NIS = NIKEL SATINATO
 NIN = NIKEL NERO

Finish

OTL = POLISHED BRASS
 OSA = SATIN BRASS
 OBR = SATIN BRONZE
 CRO = CHROME PLATED
 CSA = SATIN CHROME
 NIS = SATIN NICKEL
 NIN = BLACK CHROME



85 €

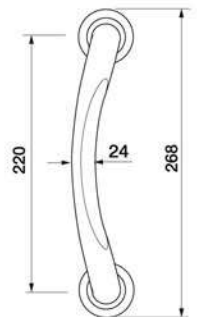
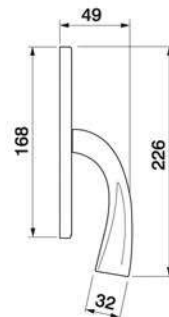
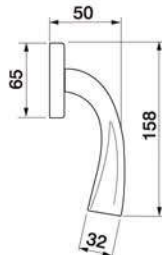
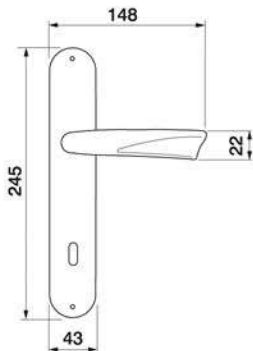
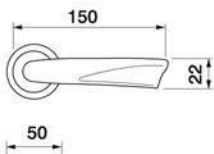

RAFT R2
 Maniglia su rosetta con bocchetta
 Door lever handle
 with rosette and escutcheon

RAFT PL
 Maniglia su rosetta placca
 Door lever handle with plate

RAFT W1
 Maniglia per finestra D.K.
 Window handle D.K.

RAFT W2
 Maniglia per finestra
 Window handle

RAFT PH
 Maniglia
 Pull handle

RAFT®

Design Studio Manital



MORELLI®
MADE IN ITALY

Finitura

OTL = OTTONE LUCIDO
 OSA = OTTONE SATINATO
 OBR = BRONZATO
 CRO = CROMATO
 CSA = CROMATO SATINATO
 NIS = NIKEL SATINATO
 NIN = NIKEL NERO

Finish

OTL = POLISHED BRASS
 OSA = SATIN BRASS
 OBR = SATIN BRONZE
 CRO = CHROME PLATED
 CSA = SATIN CHROME
 NIS = SATIN NICKEL
 NIN = BLACK CHROME

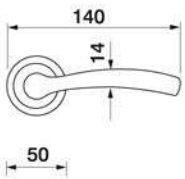
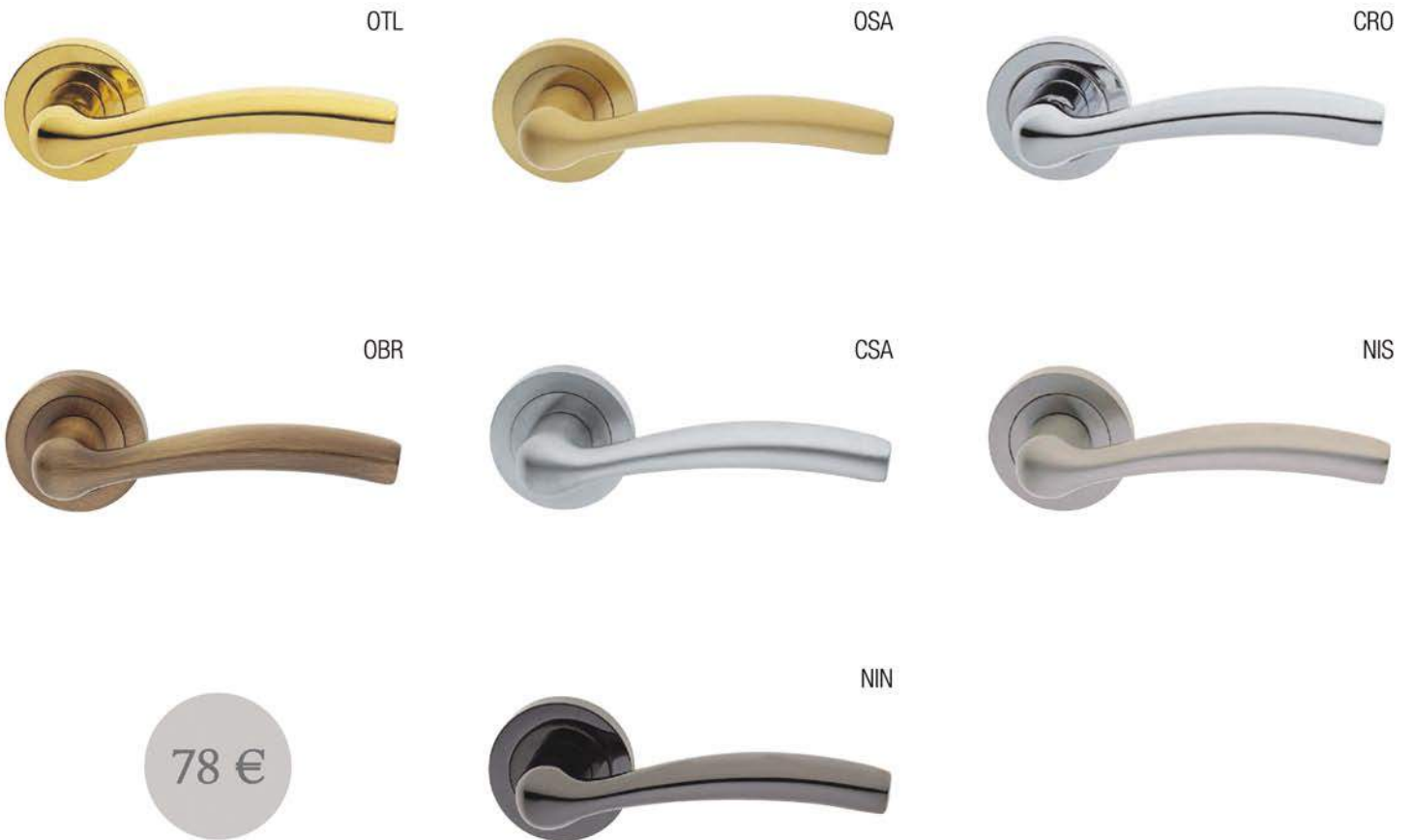

VENERA R2
 Maniglia su rosetta con bocchetta
 Door lever handle with rosette and escutcheon

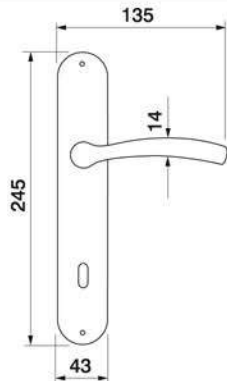

VENERA PL
 Maniglia su rosetta placca
 Door lever handle with plate

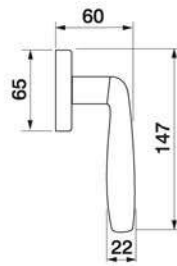

VENERA W1
 Maniglia per finestra D.K.
 Window handle D.K.

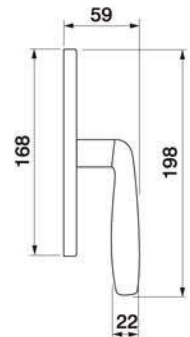

VENERA W2
 Maniglia per finestra
 Window handle

VENERA®

Designer Pedrizzetti & Associati



MORELLI®
MADE IN ITALY

Finitura

OTL = OTTONE LUCIDO
 OSA = OTTONE SATINATO
 OBR = BRONZATO
 CRO = CROMATO
 CSA = CROMATO SATINATO
 NIS = NIKEL SATINATO
 NIN = NIKEL NERO

Finish

OTL = POLISHED BRASS
 OSA = SATIN BRASS
 OBR = SATIN BRONZE
 CRO = CHROME PLATED
 CSA = SATIN CHROME
 NIS = SATIN NICKEL
 NIN = BLACK CHROME



86 €

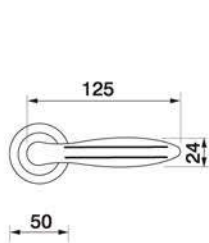

BUD R2
 Maniglia su rosetta con bocchetta
 Door lever handle with rosette and escutcheon

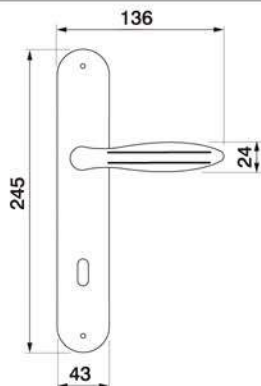

BUD PL
 Maniglia su rosetta placca
 Door lever handle with plate

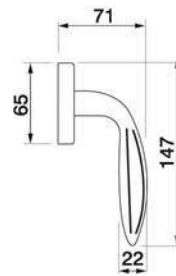

BUD W1
 Maniglia per finestra D.K.
 Window handle D.K.

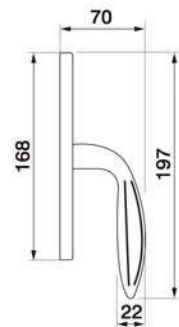

BUD W2
 Maniglia per finestra
 Window handle

BUD®

Designer Maurizio Giordano e Roberto Grossi



MORELLI®
MADE IN ITALY

Finitura

- OTL = OTTONE LUCIDO
- OSA = OTTONE SATINATO
- CRO = CROMATO
- CSA = CROMATO SATINATO
- NNK = NIKEL NERO / ORO 24K
- NIS = NIKEL SATINATO
- NIN = NIKEL NERO

Finish

- OTL = POLISHED BRASS
- OSA = SATIN BRASS
- CRO = CHROME PLATED
- CSA = SATIN CHROME
- NNK = BLACK CHROME / GOLD 24K
- NIS = SATIN NICKEL
- NIN = BLACK CHROME



97 €

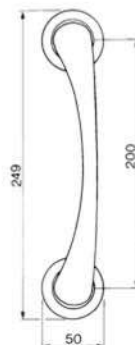
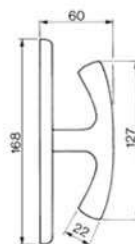
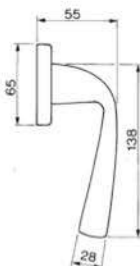
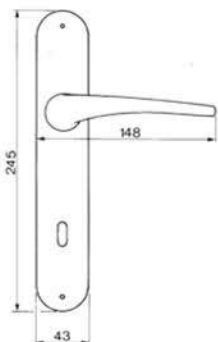
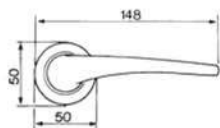

LE MANS R2
Maniglia su rosetta con bocchetta
Door lever handle
with rosette and escutcheon

LE MANS PL
Maniglia su rosetta placca
Door lever handle with plate

LE MANS W1
Maniglia per finestra D.K.
Window handle D.K.

LE MANS W2
Maniglia per finestra
Window handle

LE MANS PH
Maniglia
Pull handle

LE MANS®

Designer Dorina Camusso



MORELLI®
MADE IN ITALY

Finitura

- OTL = OTTONE LUCIDO
- OSA = OTTONE SATINATO
- CRO = CROMATO
- CSA = CROMATO SATINATO
- NNK = NIKEL NERO / ORO 24K
- NIS = NIKEL SATINATO
- NIN = NIKEL NERO

Finish

- OTL = POLISHED BRASS
- OSA = SATIN BRASS
- CRO = CHROME PLATED
- CSA = SATIN CHROME
- NNK = BLACK CHROME / GOLD 24K
- NIS = SATIN NICKEL
- NIN = BLACK CHROME



85 €

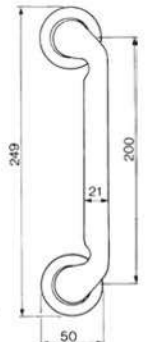
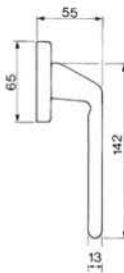
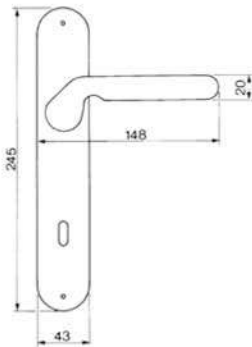
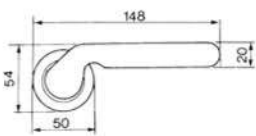

NIRVANA R2
Maniglia su rosetta con bocchetta
Door lever handle
with rosette and escutcheon

NIRVANA PL
Maniglia su rosetta placca
Door lever handle with plate

NIRVANA W1
Maniglia per finestra D.K.
Window handle D.K.

NIRVANA W2
Maniglia per finestra
Window handle

NIRVANA PH
Maniglia
Pull handle

NIRVANA®

Designer Simon Quick



MORELLI®
MADE IN ITALY

Finitura

OTL = OTTONE LUCIDO
 OSA = OTTONE SATINATO
 OBR = BRONZATO
 CRO = CROMATO
 CSA = CROMATO SATINATO
 NIS = NIKEL SATINATO
 NIN = NIKEL NERO

Finish

OTL = POLISHED BRASS
 OSA = SATIN BRASS
 OBR = SATIN BRONZE
 CRO = CHROME PLATED
 CSA = SATIN CHROME
 NIS = SATIN NICKEL
 NIN = BLACK CHROME



OTL



OSA



CRO



OBR



CSA



NIS



NIN



78 €

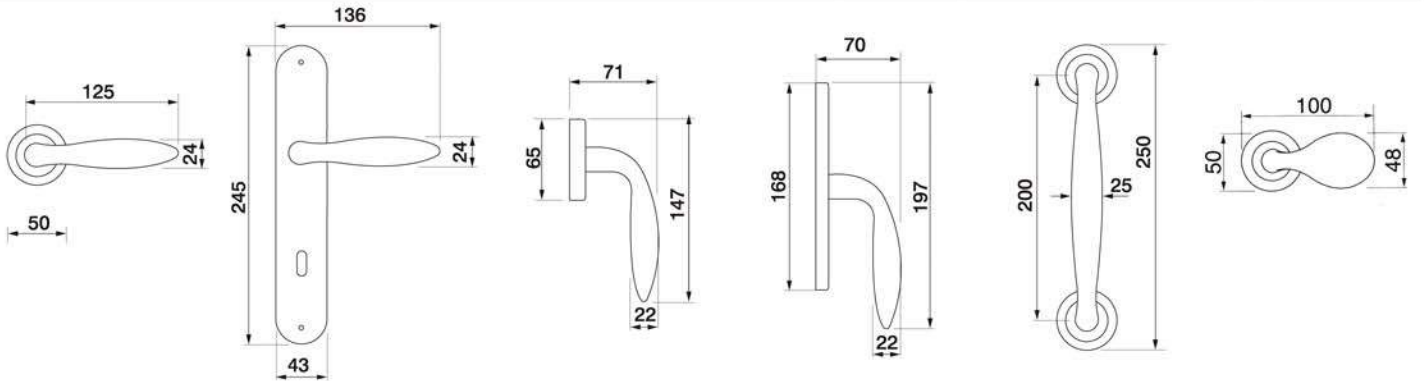

AIR R2
 Maniglia su rosetta con bocchetta
 Door lever handle
 with rosette and escutcheon

AIR PL
 Maniglia su rosetta placca
 Door lever handle with plate

AIR W1
 Maniglia per finestra D.K.
 Window handle D.K.

AIR W2
 Maniglia per finestra
 Window handle

AIR PH
 Maniglia
 Pull handle

AIR-2 R2
 Maniglia su rosetta con bocchetta
 Mortice knob
 with rosette and escutcheon

AIR®

Design Studio Manital



MORELLI®
MADE IN ITALY

Finitura

OTL = OTTONE LUCIDO
 OSA = OTTONE SATINATO
 OBR = BRONZATO
 CRO = CROMATO
 CSA = CROMATO SATINATO
 NIS = NIKEL SATINATO
 NIN = NIKEL NERO

Finish

OTL = POLISHED BRASS
 OSA = SATIN BRASS
 OBR = SATIN BRONZE
 CRO = CHROME PLATED
 CSA = SATIN CHROME
 NIS = SATIN NICKEL
 NIN = BLACK CHROME



68 €

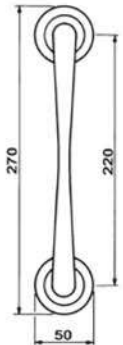
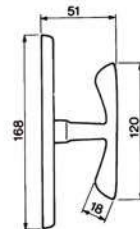
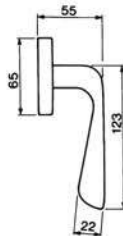
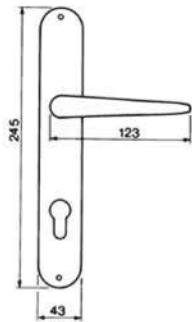
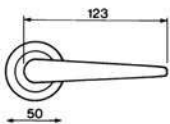

PETRA R2
 Maniglia su rosetta con bocchetta
 Door lever handle
 with rosette and escutcheon

PETRA PL
 Maniglia su rosetta placca
 Door lever handle with plate

PETRA W1
 Maniglia per finestra D.K.
 Window handle D.K.

PETRA W2
 Maniglia per finestra
 Window handle

PETRA PH
 Maniglia
 Pull handle

PETRA®

Designer Valentina Downey



MORELLI®
MADE IN ITALY

Finitura

OTL = OTTONE LUCIDO
 OSA = OTTONE SATINATO
 OBR = BRONZATO
 CRO = CROMATO
 CSA = CROMATO SATINATO
 NIS = NIKEL SATINATO
 NIN = NIKEL NERO

Finish

OTL = POLISHED BRASS
 OSA = SATIN BRASS
 OBR = SATIN BRONZE
 CRO = CHROME PLATED
 CSA = SATIN CHROME
 NIS = SATIN NICKEL
 NIN = BLACK CHROME



OTL



OSA



CRO



OBR



CSA



NIS



NIN



74 €

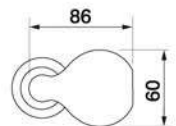
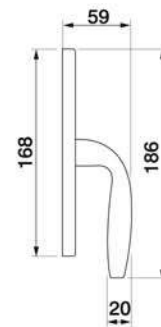
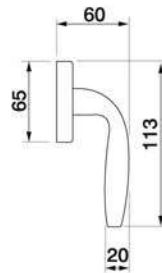
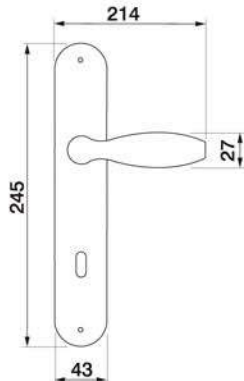
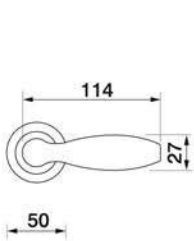

SIENA R2
 Maniglia su rosetta con bocchetta
 Door lever handle
 with rosette and escutcheon

SIENA PL
 Maniglia su rosetta placca
 Door lever handle with plate

SIENA W1
 Maniglia per finestra D.K.
 Window handle D.K.

SIENA W2
 Maniglia per finestra
 Window handle

SIENA-2 R2
 Maniglia su rosetta con bocchetta
 Mortice knob
 with rosette and escutcheon

SIENA®

Designer Maurizio Giordano e Roberto Grossi



MORELLI®
MADE IN ITALY

Finitura

- OTL = OTTONE LUCIDO
- OSA = OTTONE SATINATO
- OBR = BRONZATO
- CRO = CROMATO
- CSA = CROMATO SATINATO
- NIS = NIKEL SATINATO

Finish

- OTL = POLISHED BRASS
- OSA = SATIN BRASS
- OBR = SATIN BRONZE
- CRO = CHROME PLATED
- CSA = SATIN CHROME
- NIS = SATIN NICKEL



OTL

OSA

CRO



OBR

CSA

NIS



74 €

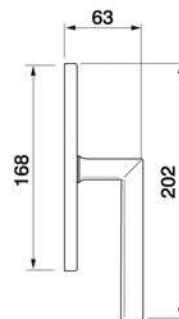
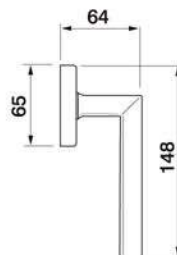
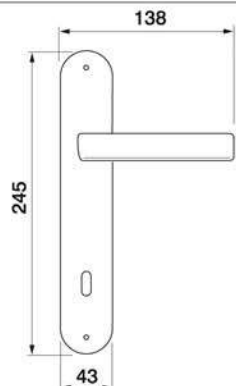
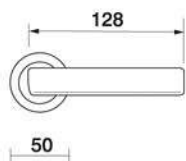

STELLAR2

Maniglia su rosetta con bocchetta
Door lever handle with rosette and escutcheon

STELLA PL

Maniglia su rosetta placca
Door lever handle with plate

STELLA W1

Maniglia per finestra D.K.
Window handle D.K.

STELLA W2

Maniglia per finestra
Window handle

STELLA®

Design Studio Manital



MORELLI®
MADE IN ITALY

Finitura

- OTL = OTTONE LUCIDO
- OSA = OTTONE SATINATO
- COT = CROMATO / OTT.LUC.
- NNO = NIKEL NERO / OTT. LUC.
- NIS/NIK = NIKEL SAT./NIKEL
- CRO = CROMATO
- CSA/CRO = CROM. SAT./CROM.

Finish

- OTL = POLISHED BRASS
- OSA = SATIN BRASS
- COT = CHR. PLAT. / POL. BRASS
- NNO = BLACK CHR./ POL. BRASS
- NIS/NIK = SAT. NICKEL/NICKEL
- CRO = CHROME PLATED
- CSA/CRO = SAT. CHR./CHR. PLATED



OTL



OSA



CRO



NNO



COT



CSA



112 €

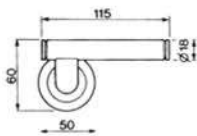

TELESCOPE R2
Maniglia su rosetta con bocchetta
Door lever handle with rosette and escutcheon

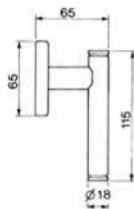

TELESCOPE W1
Maniglia per finestra D.K.
Window handle D.K.

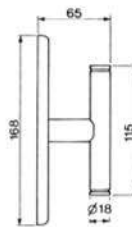

TELESCOPE W2
Maniglia per finestra
Window handle

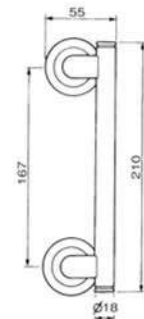

TELESCOPE PH
Maniglia
Pull handle

TELESCOPE®

Designer Davide Mercatali



MORELLI®
MADE IN ITALY

Finitura

OTL = OTTONE LUCIDO
 OSA = OTTONE SATINATO
 OBR = BRONZATO
 CRO = CROMATO
 CSA = CROMATO SATINATO
 NIS = NIKEL SATINATO
 NIN = NIKEL NERO

Finish

OTL = POLISHED BRASS
 OSA = SATIN BRASS
 OBR = SATIN BRONZE
 CRO = CHROME PLATED
 CSA = SATIN CHROME
 NIS = SATIN NICKEL
 NIN = BLACK CHROME

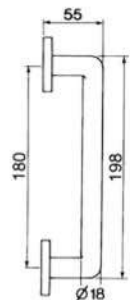
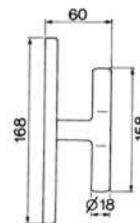
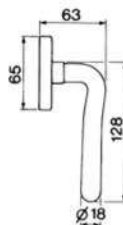
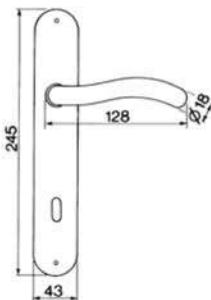
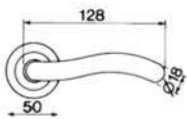

SNAKE R2
 Maniglia su rosetta con bocchetta
 Door lever handle
 with rosette and escutcheon

SNAKE PL
 Maniglia su rosetta placca
 Door lever handle with plate

SNAKE W1
 Maniglia per finestra D.K.
 Window handle D.K.

SNAKE W2
 Maniglia per finestra
 Window handle

SNAKE PH
 Maniglia
 Pull handle

SNAKE®

Designer Davide Mercatali



MORELLI®
MADE IN ITALY

Finitura

- OTL = OTTONE LUCIDO
- COT = CROMATO / OTT.LUC.
- NNO = NIKEL NERO / OTT. LUC.
- CRO = CROMATO
- CSA/CRO = CROM. SAT./CROM.

Finish

- OTL = POLISHED BRASS
- COT = CHR. PLATED/ POL. BRASS
- NNO = BLACK CHR./ POL. BRASS
- CRO = CHROME PLATED
- CSA/CRO = SATIN CHROME/CHROME



OTL



COT



CRO



NNO

101 €



CSA / CRO

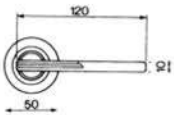

VERONICA R2
Maniglia su rosetta con bocchetta
Door lever handle
with rosette and escutcheon

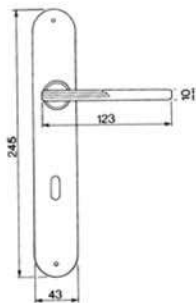

VERONICA PL
Maniglia su rosetta placca
Door lever handle with plate

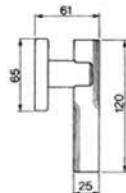

VERONICA W1
Maniglia per finestra D.K.
Window handle D.K.

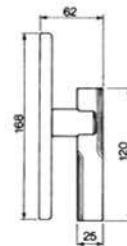

VERONICA W2
Maniglia per finestra
Window handle

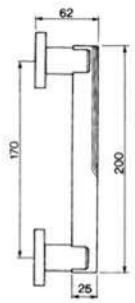

VERONICA PH
Maniglia
Pull handle

VERONICA®
Design Studio Manital



MORELLI®
MADE IN ITALY

Finitura

OTL = OTTONE LUCIDO
 COT = CROMATO / OTT.LUC.
 NNO = NIKEL NERO / OTT. LUC.
 CRO = CROMATO
 CSA = CROMATO SATINATO
 NIS = NIKEL SATINATO

Finish

OTL = POLISHED BRASS
 COT = CHR. PLATED / POL. BRASS
 NNO = BLACK CHR./ POL. BRASS
 CRO = CHROME PLATED
 CSA = SATIN CHROME
 NIS = SATIN NICKEL



OTL



COT



CRO



NIS



CSA



NNO



75 €

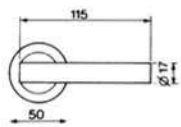

CALLA R2
 Maniglia su rosetta con bocchetta
 Door lever handle
 with rosette and escutcheon

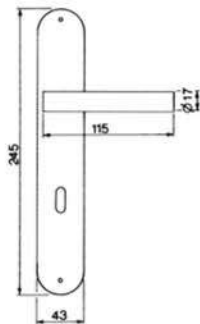

CALLA PL
 Maniglia su rosetta placca
 Door lever handle with plate

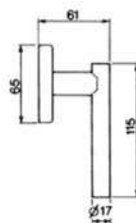

CALLA W1
 Maniglia per finestra D.K.
 Window handle D.K.

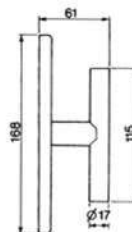

CALLA W2
 Maniglia per finestra
 Window handle

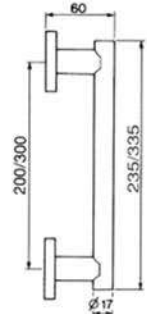

CALLA PH
 Maniglia
 Pull handle

CALLA®

Design Studio Manital



MORELLI®
MADE IN ITALY

Finitura

- OTL = OTTONE LUCIDO
- OSA = OTTONE SATINATO
- OBR = BRONZATO
- CRO = CROMATO
- CSA = CROMATO SATINATO
- NIS = NIKEL SATINATO

Finish

- OTL = POLISHED BRASS
- OSA = SATIN BRASS
- OBR = SATIN BRONZE
- CRO = CHROME PLATED
- CSA = SATIN CHROME
- NIS = SATIN NICKEL



OTL

OSA

CRO



OBR

CSA

NIS



73 €

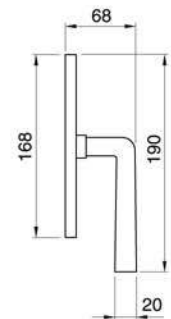
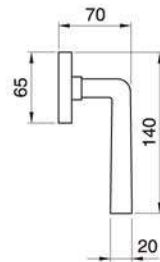
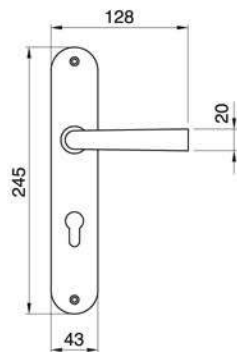
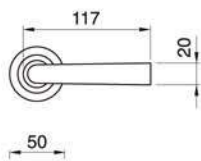

IDRO R2
Maniglia su rosetta con bocchetta
Door lever handle with rosette and escutcheon

IDRO PL
Maniglia su rosetta placca
Door lever handle with plate

IDRO W1
Maniglia per finestra D.K.
Window handle D.K.

IDRO W2
Maniglia per finestra
Window handle

IDRO®

Design Studio Manital



MORELLI®
MADE IN ITALY

Finitura

- OTL = OTTONE LUCIDO
- OSA = OTTONE SATINATO
- OBR = BRONZATO
- CRO = CROMATO
- CSA = CROMATO SATINATO
- NIN = NIKEL NERO

Finish

- OTL = POLISHED BRASS
- OSA = SATIN BRASS
- OBR = SATIN BRONZE
- CRO = CHROME PLATED
- CSA = SATIN CHROME
- NIN = BLACK CHROME



OTL

OSA

CRO



OBR

CSA

NIN



64 €

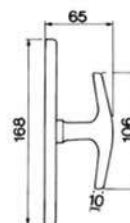
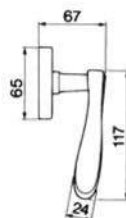
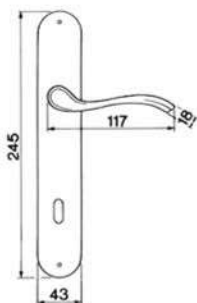
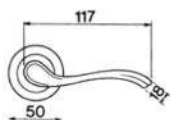

ERICA R2

Maniglia su rosetta con bocchetta
Door lever handle with rosette and escutcheon

ERICA PL

Maniglia su rosetta placca
Door lever handle with plate

ERICA W1

Maniglia per finestra D.K.
Window handle D.K.

ERICA W2

Maniglia per finestra
Window handle

ERICA®

Design Studio Manital



MORELLI®
MADE IN ITALY

Finitura

OTL = OTTONE LUCIDO
 OSA = OTTONE SATINATO
 OBR = BRONZATO
 CRO = CROMATO
 CSA = CROMATO SATINATO
 NIN = NIKEL NERO

Finish

OTL = POLISHED BRASS
 OSA = SATIN BRASS
 OBR = SATIN BRONZE
 CRO = CHROME PLATED
 CSA = SATIN CHROME
 NIN = BLACK CHROME



52 €

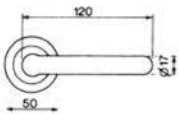

IRIS R2
 Maniglia su rosetta con bocchetta
 Door lever handle
 with rosette and escutcheon

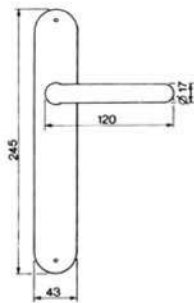

IRIS PL
 Maniglia su rosetta placca
 Door lever handle with plate

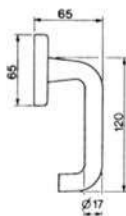

IRIS W1
 Maniglia per finestra D.K.
 Window handle D.K.



IRIS W2
 Maniglia per finestra
 Window handle



IRIS PH
 Maniglia
 Pull handle

IRIS®

Design Studio Manital



MORELLI®
MADE IN ITALY

Finitura

- OTL = OTTONE LUCIDO
- OSA = OTTONE SATINATO
- OBR = BRONZATO
- CRO = CROMATO
- CSA = CROMATO SATINATO
- NIS = NIKEL SATINATO

Finish

- OTL = POLISHED BRASS
- OSA = SATIN BRASS
- OBR = SATIN BRONZE
- CRO = CHROME PLATED
- CSA = SATIN CHROME
- NIS = SATIN NICKEL



OTL



OSA



CRO



OBR



CSA



NIS

52 €

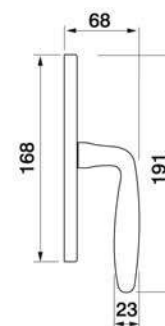
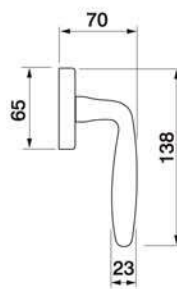
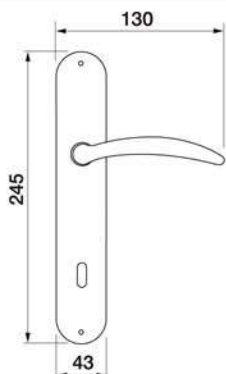
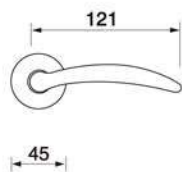

FRANCY R3-E
Maniglia su rosetta con bocchetta
Door lever handle with rosette and escutcheon

FRANCY PL
Maniglia su rosetta placca
Door lever handle with plate

FRANCY W1
Maniglia per finestra D.K.
Window handle D.K.

FRANCY W2
Maniglia per finestra
Window handle

FRANCY®

Design Studio Manital



MORELLI®
MADE IN ITALY

Finitura

OTL = OTTONE LUCIDO
 OSA = OTTONE SATINATO
 OBR = BRONZATO
 CRO = CROMATO
 CSA = CROMATO SATINATO
 NIS = NIKEL SATINATO

Finish

OTL = POLISHED BRASS
 OSA = SATIN BRASS
 OBR = SATIN BRONZE
 CRO = CHROME PLATED
 CSA = SATIN CHROME
 NIS = SATIN NICKEL



OTL



OSA



CRO



OBR



CSA



NIS



48 €

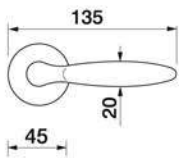

DERBY R3-E
 Maniglia su rosetta con bocchetta
 Door lever handle with rosette and escutcheon

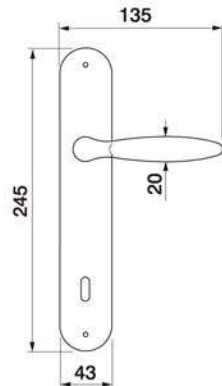

DERBY PL
 Maniglia su rosetta placca
 Door lever handle with plate

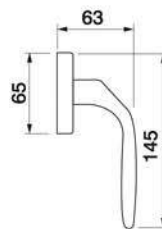

DERBY W1
 Maniglia per finestra D.K.
 Window handle D.K.

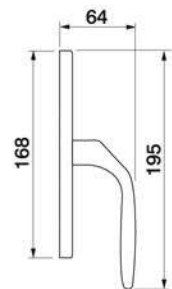

DERBY W2
 Maniglia per finestra
 Window handle

DERBY®

Design Studio Manital



MORELLI®
MADE IN ITALY

Finitura

- OTL = OTTONE LUCIDO
- OSA = OTTONE SATINATO
- OBR = BRONZATO
- CRO = CROMATO
- CSA = CROMATO SATINATO
- NIS = NIKEL SATINATO
- NIN = NIKEL NERO

Finish

- OTL = POLISHED BRASS
- OSA = SATIN BRASS
- OBR = SATIN BRONZE
- CRO = CHROME PLATED
- CSA = SATIN CHROME
- NIS = SATIN NICKEL
- NIN = BLACK CHROME



42 €

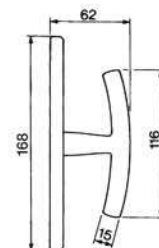
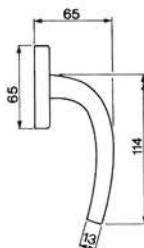
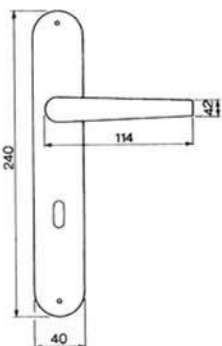
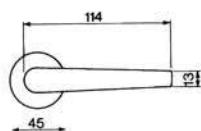

LILLA R3-E
Maniglia su rosetta con bocchetta
Door lever handle with rosette and escutcheon

LILLA PL
Maniglia su rosetta placca
Door lever handle with plate

LILLA W1
Maniglia per finestra D.K.
Window handle D.K.

LILLA W2
Maniglia per finestra
Window handle

LILLA®

Design Studio Manital



MORELLI®
MADE IN ITALY

Finitura

OTL = OTTONE LUCIDO
 OBA = BRONZO ANTICATO
 FEA = FERRO ANTICATO
 BGO = BRONZO OPACO
 CRO = CROMATO
 CSA = CROMATO SATINATO
 OBR = BRONZATO
 ROK = RODIO / ORO 24K

Finish

OTL = POLISHED BRASS
 OBA = ANTIQUE BRONZE
 FEA = ANTIQUE IRON
 BGO = BRONZE MATT
 CRO = CHROME PLATED
 CSA = SATIN CHROME
 OBR = SATIN BRONZE
 NNK = BLACK CHROME/GOLD 24K



OTL



CRO



CSA



OBR



BGO



ROK



OBA



FEA



92 €

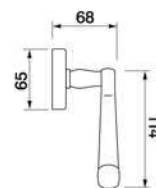
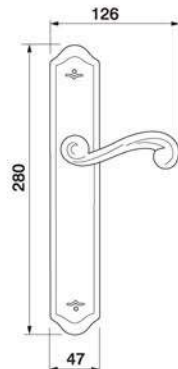
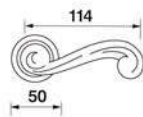

PLAZA R2
 Maniglia su rosetta con bocchetta
 Door lever handle
 with rosette and escutcheon

PLAZA PL
 Maniglia su rosetta placca
 Door lever handle with plate

PLAZA W1
 Maniglia per finestra D.K.
 Window handle D.K.

PLAZA®



MORELLI®
MADE IN ITALY

Finitura

OTL = OTTONE LUCIDO
 OBA = BRONZO ANTICATO
 FEA = FERRO ANTICATO
 CRO = CROMATO
 CSA = CROMATO SATINATO
 OBR = BRONZATO
 ROK = RODIO / ORO 24K
 BGO = BRONZO OPACO

Finish

OTL = POLISHED BRASS
 OBA = ANTIQUE BRONZE
 FEA = ANTIQUE IRON
 CRO = CHROME PLATED
 CSA = SATIN CHROME
 OBR = SATIN BRONZE
 NNK = BLACK CHROME/GOLD 24K
 BGO = BRONZE MATT



OTL



OBA



CRO



FEA



OBR



CSA



ROK



BGO



84 €

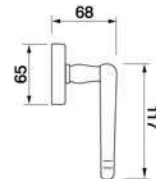
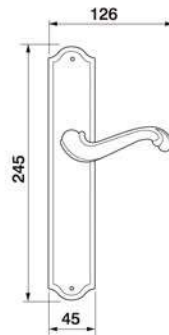
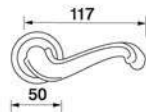

BAROCCO R2
 Maniglia su rosetta con bocchetta
 Door lever handle
 with rosette and escutcheon

BAROCCO PL
 Maniglia su rosetta placca
 Door lever handle with plate

BAROCCO W1
 Maniglia per finestra D.K.
 Window handle D.K.

BAROCCO®



MORELLI®
MADE IN ITALY

Finitura

OTL = OTTONE LUCIDO
CRO = CROMATO
CSA = CROMATO SATINATO
OBR = BRONZATO
BGO = BRONZO OPACO
FEA = FERRO ANTICATO

Finish

OTL = POLISHED BRASS
CRO = CHROME PLATED
CSA = SATIN CHROME
OBR = SATIN BRONZE
BGO = BRONZE MATT
FEA = ANTIQUE IRON



80 €

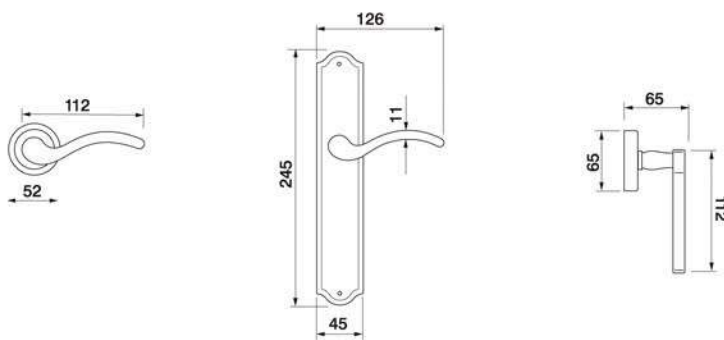

PATRICIA R2
Maniglia su rosetta con bocchetta
Door lever handle
with rosette and escutcheon

PATRICIA PL
Maniglia su rosetta placca
Door lever handle with plate

PATRICIA W1
Maniglia per finestra D.K.
Window handle D.K.

PATRICIA®



MORELLI®
MADE IN ITALY

Finitura

- OTL = OTTONE LUCIDO
- OSA/OTL = OTT. SAT./OTT. LUC.
- OBA = BRONZO ANTICATO
- CSA/CRO = CRO. SAT./CROM.
- NIS/NIK = NIKEL SAT./NIKEL
- OBR = BRONZATO
- FEA = FERRO ANTICATO
- BGO = BRONZO OPACO

Finish

- OTL = POLISHED BRASS
- OSA/OTL = SAT. BRASS/POL. BRASS
- OBA = ANTIQUE BRONZE
- CSA/CRO = SAT. CHR/CHR. PLATED
- NIS/NIK = SAT. NICKEL/NICKEL
- OBR = SATIN BRONZE
- FEA = ANTIQUE IRON
- BGO = BRONZE MATT

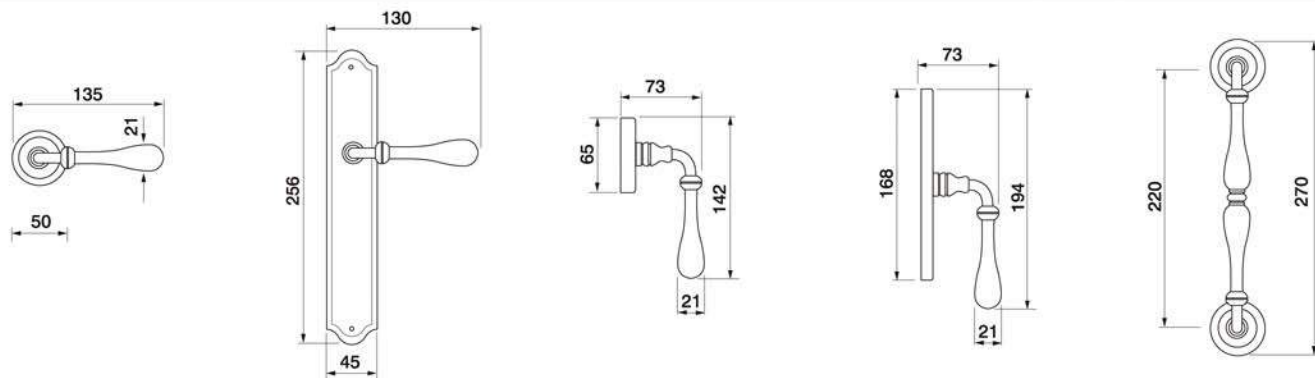

MARY R4
Maniglia su rosetta con bocchetta
Door lever handle
with rosette and escutcheon

MARY PL
Maniglia su rosetta placca
Door lever handle with plate

MARY W1
Maniglia per finestra D.K.
Window handle D.K.

MARY W2
Maniglia per finestra
Window handle

MARY PH
Maniglia
Pull handle

MARY®



MORELLI®
MADE IN ITALY

MANIGLIA CON CERAMICA

Finitura

OTL = OTTONE LUCIDO
 OBR = BRONZATO
 OBA = BRONZO ANTICATO

Ceramiche

DEC = DECORATA
 BIA = BIANCA
 CHA = CHAMPAGNE
 ANT = ANTICATA

DOOR LEVER HANDLE WITH CERAMIC

Finish

OTL = POLISHED BRASS
 OBR = SATIN BRONZE
 OBA = ANTIQUE BRONZE

Ceramic

DEC = DECORATED
 BIA = WHITE
 CHA = CHAMPAGNE
 ANT = CRACKLED



60 €



OTL / DEC



OBR / DEC



OBA / DEC



OTL / BIA



OBR / BIA



OBA / BIA



OTL / ANT



OBR / ANT



OBA / ANT



OTL / CHA



OBR / CHA



OBA / CHA

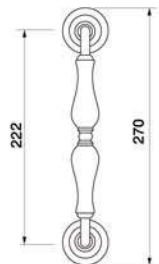
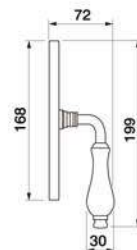
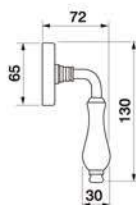
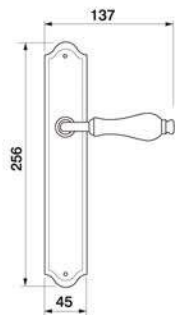
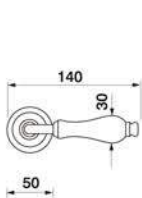

CERAMICA R4
 Maniglia su rosetta con bocchetta
 Door lever handle
 with rosettes and escutcheon

CERAMICA PL
 Maniglia su rosetta placca
 Door lever handle with plate

CERAMICA W1
 Maniglia per finestra D.K.
 Window handle D.K.

CERAMICA W2
 Maniglia per finestra
 Window handle

CERAMICA PH
 Maniglia
 Pull handle

CERAMICA®



MORELLI®
MADE IN ITALY

MANIGLIE SU PLACCA STRETTA

DOOR LEVER HANDLE ON NARROW PLATE

Finitura

OTL = OTTONE LUCIDO
OBR = BRONZATO
CSA = CROMATO SATINATO
CRO = CROMATO

Finish

OTL = POLISHED BRASS
OBR = SATIN BRONZE
CSA = SATIN CHROME
CRO = CHROME PLATED

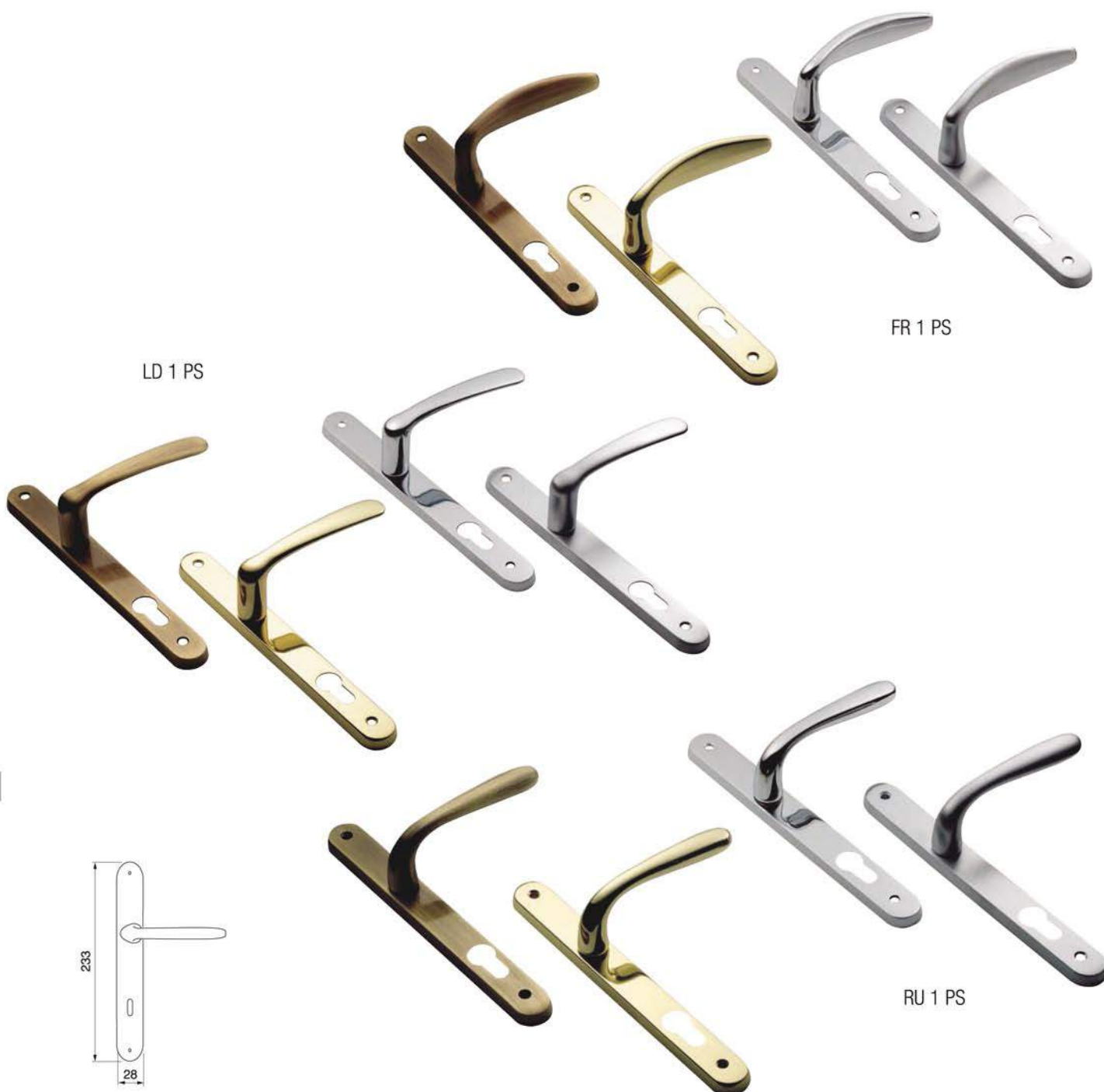

ACCESSORIES

MANIGLIONI ALZANTE SCORREVOLE

PULL HANDLES

Finitura

OTL = OTTONE LUCIDO
 OSA = OTTONE SATINATO
 OBR = BRONZATO
 CRO = CROMATO
 CSA = CROMATO SATINATO

Finish

OTL = POLISHED BRASS
 OSA = SATIN BRASS
 OBR = SATIN BRONZE
 CRO = CHROME PLATED
 CSA = SATIN CHROME



AR25 ASY

Coppia di maniglioni mm 250
 con meccanismo metallo con placca foro yale
 Pair pull handle on plate cylinder profile

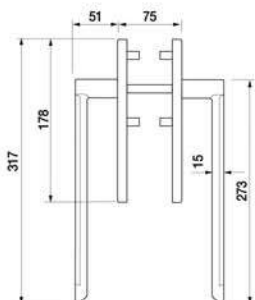

AR25 AS

Maniglione mm 250
 con molla meccanismo metallo
 Single pull handle on blank plate

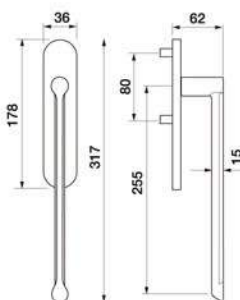

AR25 ASN

Maniglione mm 250 con molla
 meccanismo metallo completo di nicchia
 Single pull handle on blank plate
 and flush pull plate

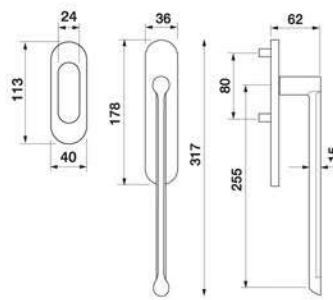

IR25 ASY/Q

Coppia di maniglioni mm 250
 con meccanismo metallo con placca foro yale
 Pair pull handle on plate cylinder profile

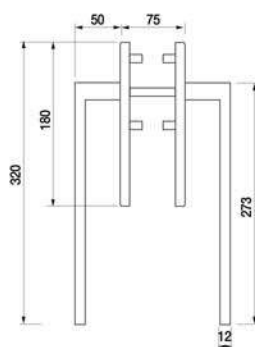

IR25 AS/Q

Maniglione mm 250
 con molla meccanismo metallo
 Single pull handle on blank plate

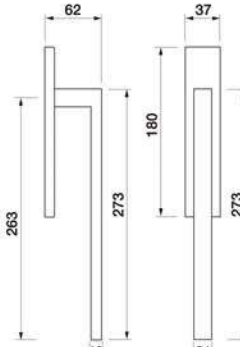

IR25 ASN/Q

Maniglione mm 250 con molla
 meccanismo metallo completo di nicchia
 Single pull handle on blank plate
 and flush pull plate

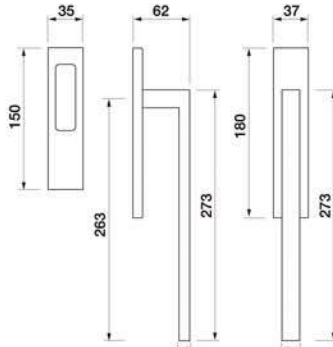

Finitura

OTL = OTTONE LUCIDO
 OSA = OTTONE SATINATO
 OBR = BRONZATO
 CRO = CROMATO
 CSA = CROMATO SATINATO

MANIGLIONI ALZANTE SCORREVOLE

PULL HANDLES

Finish

OTL = POLISHED BRASS
 OSA = SATIN BRASS
 OBR = SATIN BRONZE
 CRO = CHROME PLATED
 CSA = SATIN CHROME

IR25 ASY

Coppia di maniglioni mm 250
 con meccanismo metallo con placca foro yale
 Pair pull handle on plate cylinder profile

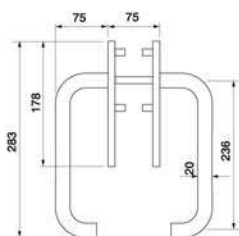
**IR25 AS**

Maniglione mm 250
 con molla meccanismo metallo
 Single pull handle on blank plate

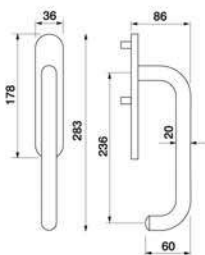
**IR25 ASN**

Maniglione mm 250 con molla
 meccanismo metallo completo di nicchia
 Single pull handle on blank plate
 and flush pull plate

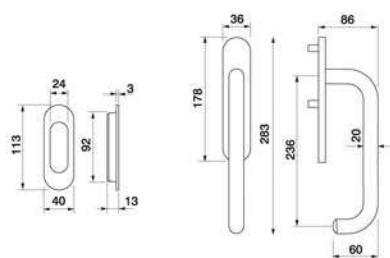

BOCCHETTE

ESCUTCHEON

ART. A

Bocchetta tonda
Round escutcheon



ART. USI

Bocchetta tonda
Round escutcheon



ART. B

Bocchetta tonda
Round escutcheon



ART. G

Bocchetta tonda
Round escutcheon



ART. C

Bocchetta tonda
Round escutcheon



ART. Z

Bocchetta Ovale
Oval escutcheon



ART. D

Bocchetta tonda
Round escutcheon



ART. Q

Bocchetta quadra
Square escutcheon



ART. A

Foro doppia mappa
Escutcheon safety key profile



ART. Q/E

Bocchetta quadra economica
Budget square escutcheon

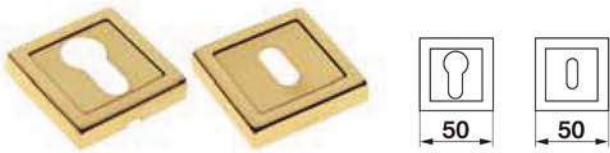

ART. USI/Q

Bocchetta quadra
Square escutcheon



ART. AI 2/USI Q

Bocchetta quadra Ultra Slim
Square escutcheon Ultra Slim

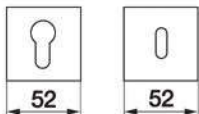

ART. AI 2/USI

Bocchetta tonda Ultra Slim
Round escutcheon Ultra Slim

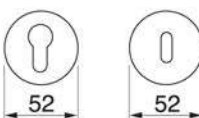
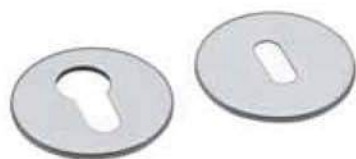

ART. QES

Bocchetta quadra
Square escutcheon

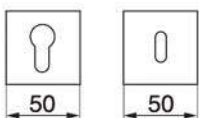

ART. QE

Bocchetta quadra
Square escutcheon

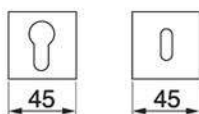

ART. AI 2

Bocchetta tonda
Round escutcheon

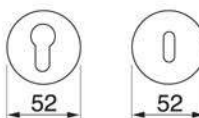

ART. ZR

Bocchetta quadra
Square escutcheon

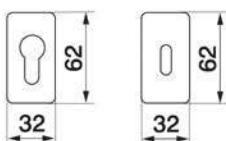

NOTTOLINI PER W. C.

W.C. LATCHES

ART. LU 40

Nottolino W.C.
W.C. latch

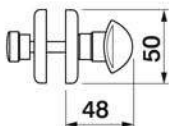

ART. USI/40

Nottolino W.C.
W.C. latch

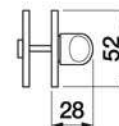

ART. LE 40

Nottolino W.C.
W.C. latch

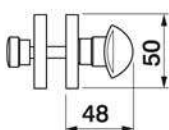

ART. BO 40

Nottolino W.C.
W.C. latch

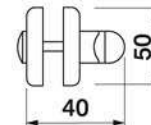

ART. LI 40

Nottolino W.C.
W.C. latch

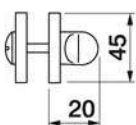

ART. IR 40

Nottolino W.C.
W.C. latch

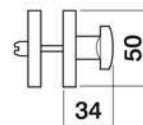

ART. LM 40 L/O

Nottolino W.C. c/finestra L/O
W.C. Latch w/Indicator

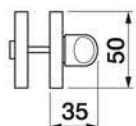

ART. LM 40

Nottolino W.C.
W.C. latch

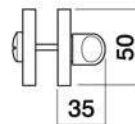

ART. TD 40 Q/E

Nottolino W.C. su rosetta quadra economica
W.C. Latch on budget square rose

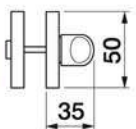
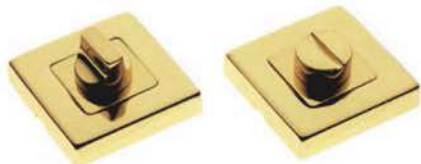

ART. TD 40 Q

Nottolino W.C. su rosetta quadra
W.C. Latch on square rose

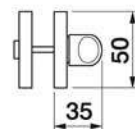

ART. USI 40/Q

Nottolino W.C. su rosetta quadra
W.C. Latch on square rose

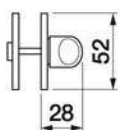

Finiture disponibili su richiesta / Finishes available on request

N.B. Tutti i modelli di nottolini
sono disponibili anche con rosetta quadra
N.B. All models of W.C. latch
can be supplied with a square rose

NOTTOLINI PER W. C.

ART. 40/QES

Bocchetta quadra
W.C. Latch on square rose



ART. 40/QE

Bocchetta quadra
W.C. Latch on square rose



ART. AI 40/USI Q

Bocchetta quadra
W.C. Latch on square rose Ultra Slim



ART. AI 40/USI

Bocchetta quadra
W.C. latch Ultra Slim



ART. AI 40

Bocchetta quadra



ART. LM 40/ZR

Bocchetta quadra



Finiture disponibili su richiesta / Finishes available on request

POMOLI

KNOBS

ART. 435

Coppia pomoli con rosetta
Mortice knob w/rose
Ø 52 mm



ART. 400

Pomolo con vite passante
N.B. : Girevole solo Ø 60
Center door knob
N.B. : Mortice version only Ø 60
Ø 60 mm - Ø 70 mm



ART. 448

Coppia pomoli con rosetta
Mortice knob w/rose
Ø 45 mm



ART. 455

Pomolo con vite passante
Center door knob
Ø 70 mm



ART. 401

Pomolo con vite passante
Center door knob
Ø 60 mm - Ø 70 mm



ART. 470

Pomolo con vite passante
Center door knob
Ø 70 mm



ART. 431

Pomolo con vite passante
Center door knob
Ø 68 mm



ART. 440

Coppia pomolo con rosetta e bocchetta
Mortice knob on round rose w/escutcheon
Ø 50 mm



ART. LU 30

Pomolo con vite passante
Center door knob
Ø 70 mm



ART. AS 30

Pomolo con vite passante
N.B. : Girevole solo Ø 60
Center door knob
N.B. : Mortice version only Ø 60
Ø 60 mm - Ø 70 mm



ART. 404

Pomolo con vite passante
N.B. : Girevole solo Ø 60
Center door knob
N.B. : Mortice version only Ø 60
Ø 60 mm - Ø 70 mm



ART. 471

Pomolo con vite passante
Center door knob
Ø 80 mm



ART. 402

Coppia pomolo con rosetta e bocchetta
Mortice knob on round rose w/escutcheon

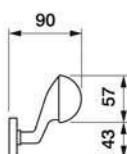

ART. 472

Pomolo con vite passante
Center door knob
Ø 93 mm



ART. 405

Coppia pomolo con rosetta e bocchetta
Mortice knob on round rose w/escutcheon

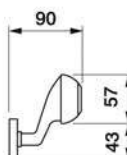

ART. 473

Pomolo con vite passante
Center door knob
Ø 93 mm



ART. 410

Coppia pomolo con rosetta e bocchetta
Mortice knob on round rose w/escutcheon

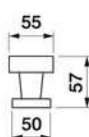

ART. 430

Coppia pomolo con rosetta e bocchetta
Mortice knob on round rose w/escutcheon



BATTENTI

DOOR KNOCKER

Finitura
 OTL = Ottone Lucido
 OBR = Bronzato

Finish
 OTL = Polished brass
 OBR = Satin Bronze

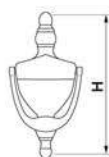
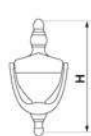

Battente inglese liscio
 Door knocker Victorian

Art. 18B
 H. 150 mm

ART. 18A
 H. 180 mm

Battente inglese con greca
 Door knocker Georgian

Art. 28B
 H. 150 mm

ART. 28A
 H. 180 mm

Battente Leone
 Door knocker Lion Head

Art. 15B
 H. 120 mm

ART. 15A
 H. 180 mm

Battente Leone
 Door knocker Lion Head

ART. 15G
 H. 260 mm

Finitura

OTL = Ottone Lucido

OBR = Bronzato

BATTENTI
DOOR KNOCKER**Finish**

OTL = Polished brass

OBR = Satin Bronze

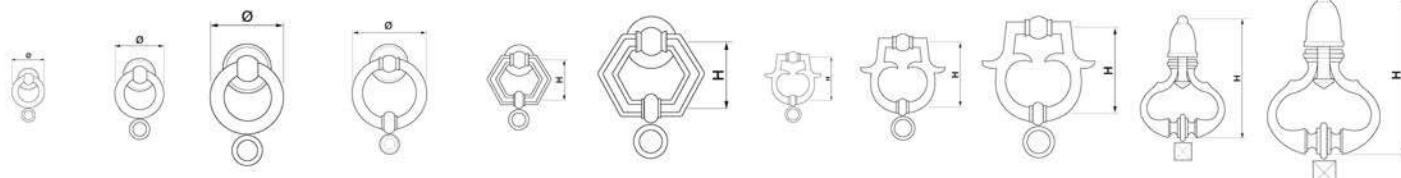
Battente anello
Door knocker RingBattente America Дверной
Door knocker AmericaBattente Esagonale
Door knocker HexagonalBattente Barocco
Door knocker BaroccoBattente Europa
Door knocker Europa**ART. 110C**
Ø 90 mm**ART. 110B**
Ø 110 mm**ART. 110A**
Ø 130 mm**ART. 27**
Ø 130 mm**ART. 20B**
H. 100 mm**ART. 20A**
H. 120 mm**Art. 10B**
H. 120 mm**ART. 10A**
H. 150 mm**ART. 10G**
H. 180 mm**Art. 29B**
H. 150 mm**ART. 29A**
H. 220 mm

MANIGLIE AD INCASSO

SLIDING DOOR ROSE

ART. 56

Frontale di trascinamento
Flush pull

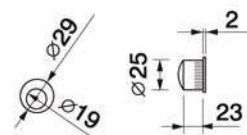

ART. 54

Coppia placche incasso cieche e con foro chiave
Sliding door rose, blind and with key hole

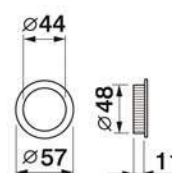
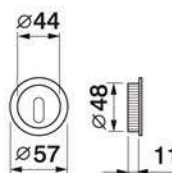

ART. 54/A

Coppia placche incasso cieche con trascinatore
Sliding door rose with flush pull

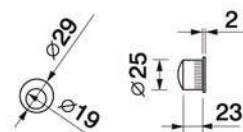
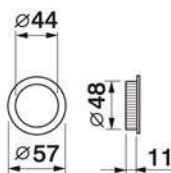

ART. 75/C

Coppia placche incasso con nottolino con anello da ambo le parti
Sliding door rose with ring turn

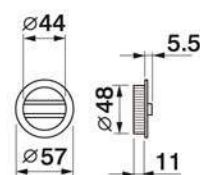

ART. 55

Coppia placche incasso con nottolino
Sliding door rose with wc turn and release

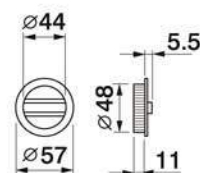

ART. 55/A

Coppia placche incasso con nottolino e trascinatore
Sliding door rose with wc turn and flush pull

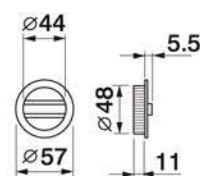
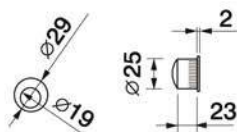

MANIGLIE AD INCASSO

SLIDING DOOR ROSE

Coppia placche incasso con nottolino ad anello
Sliding door roses with ring turn and emergency release

ART. 75

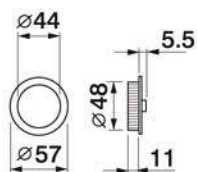

Coppia placche incasso con nottolini da ambo i lati
Sliding door roses with wc turn

ART. 55/C

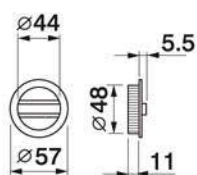

Coppia placche incasso con presa da ambo i lati
Sliding door rose

ART. 72

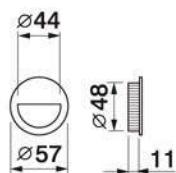

Set serratura placca incasso con nottolino e trascinatore
Set of sliding door rose with wc turn, complete of flush pull and lock

ART. 55/B

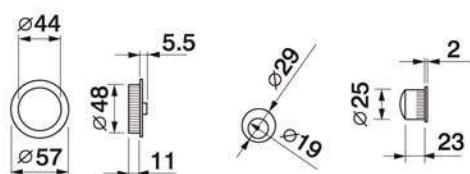

Set serratura placca incasso con nottolino con anello e trascinatore
Set of sliding door rose with ring turn, complete of flush pull and lock

ART. 75/B

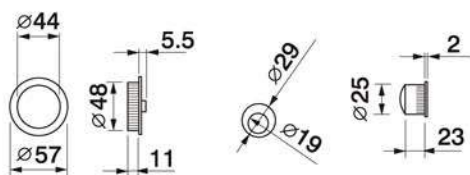

MANIGLIE AD INCASSO

SLIDING DOOR ROSE

ART. 56/Q

Frontale di trascinamento
Flush pull

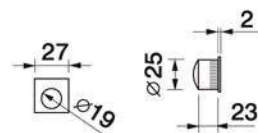

ART. 54/Q

Coppia placche incasso cieche e con foro chiave
Sliding door rose, blind and with key hole

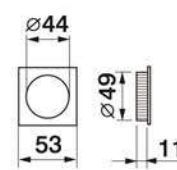
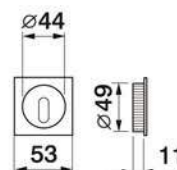

ART. 54A/Q

Coppia placche incasso cieche con trasciatore
Sliding door rose with flush pull

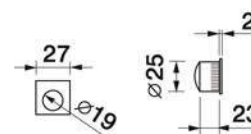
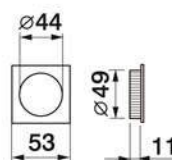

ART. 75C/Q

Coppia placche incasso con nottolino con anello da ambo le parti
Sliding door rose with ring turn

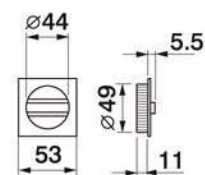
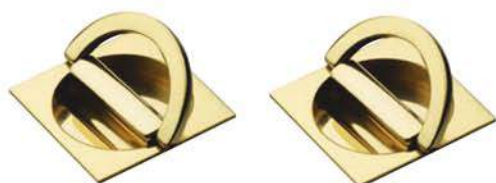

ART. 55/Q

Coppia placche incasso con nottolino
Sliding door rose with wc turn and release

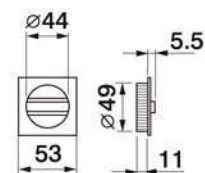

ART. 55A/Q

Coppia placche incasso con nottolino e trasciatore
Sliding door rose with wc turn and flush pull

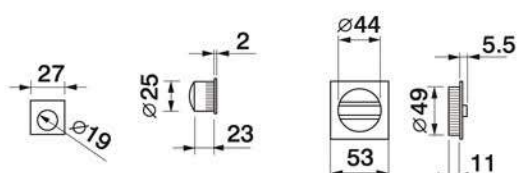

MANIGLIE AD INCASSO

SLIDING DOOR ROSE

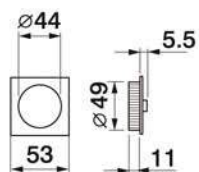

Coppia placche incasso con nottolino ad anello
Sliding door roses with ring turn and emergency release

ART. 75/Q

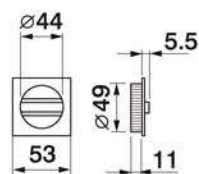

Coppia placche incasso con nottolini da ambo i lati
Sliding door rose with wc turn

ART. 55C/Q

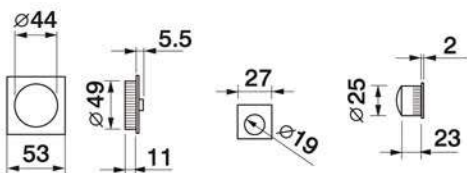

Set serratura placca incasso con nottolino e trascinatore
Set of sliding door rose with wc turn, complete of flush pull and lock

ART. 55B/Q

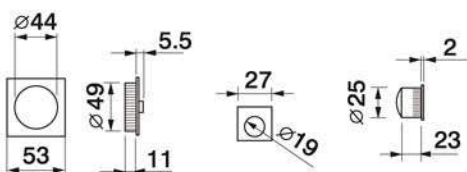
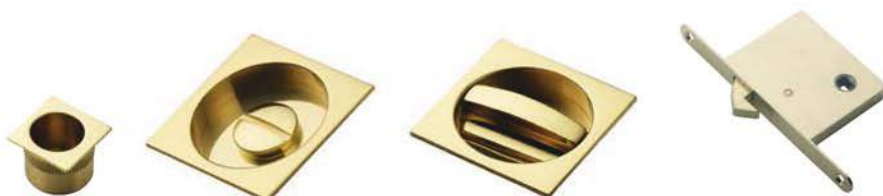

Set serratura placca incasso con nottolino con anello e trascinatore
Set of sliding door rose with ring turn, complete of flush pull and lock

ART. 75B/Q



Serratura con bordo tondo
Sliding door lock for wc turn

SR1

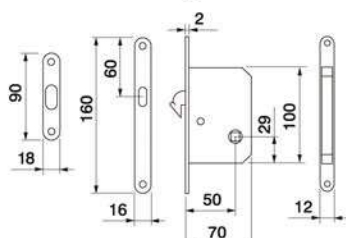

Serratura con bordo tondo e chiave
Sliding door lock with key

SR2

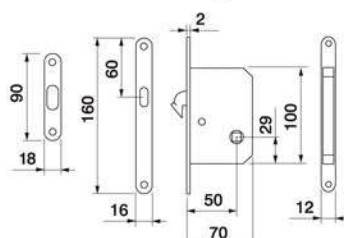

MANIGLIE AD INCASSO

SLIDING DOOR PLATE

ART. 59

Coppia placche incasso coprivite con nottolino
Sliding door plate with wc turn

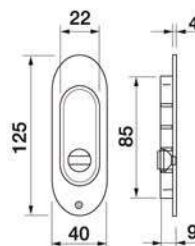

ART. 59/B

Set completo di serratura con coppia placche incasso con nottolino e trascinatore
Set of sliding door plate with wc turn, complete of flush pull and lock

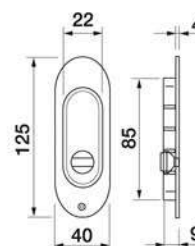
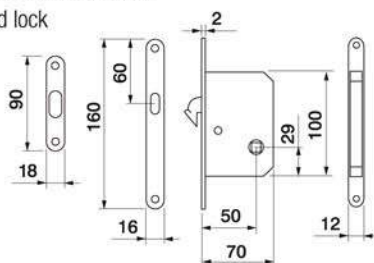

ART. 52

Coppia placche incasso con fori a vista, cieche e con foro chiave
Sliding door plate, blank and with key hole

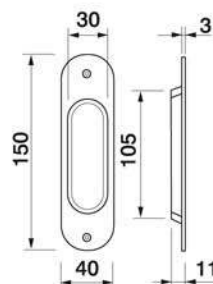

ART. 52/A

Coppia placche incasso con fori a vista con trascinatore
Sliding door plate with flush pull

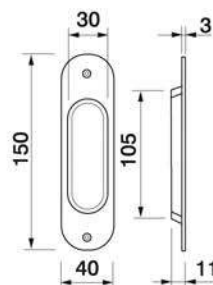
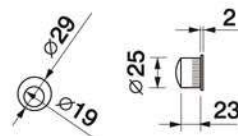

ART. 50

Coppia placche incasso con fori a vista, cieche e con foro chiave
Sliding door plate, blank and with key hole

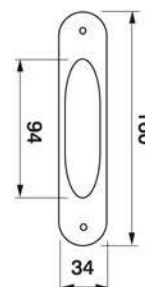

ART. 50/R

Coppia placche incasso con fori a vista, cieche e con foro chiave
Sliding door plate, blank and with key hole

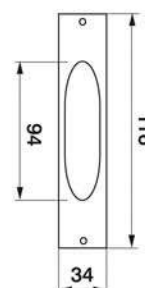

MANIGLIE AD INCASSO

SLIDING DOOR PLATE

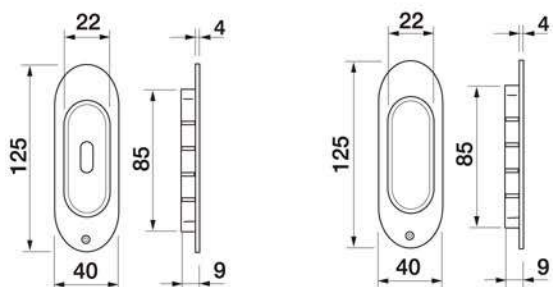

Coppia placche incasso con coprivite, cieche e con foro chiave
Sliding door plate, blank and with key hole

ART. 58

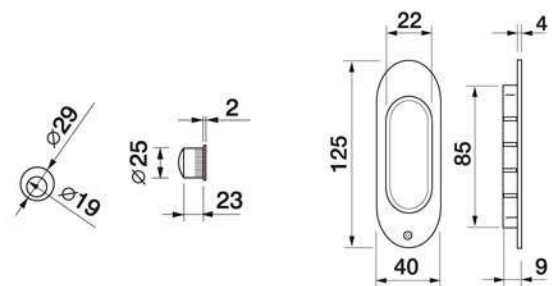

Coppia placche incasso con coprivite e trascinatore
Sliding door plate with flush pull

ART. 58/A

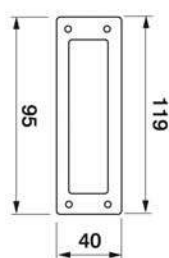

Coppia placche incasso con fori a vista, cieche e con foro chiave
Sliding door plate, blank and with key hole

ART. 51

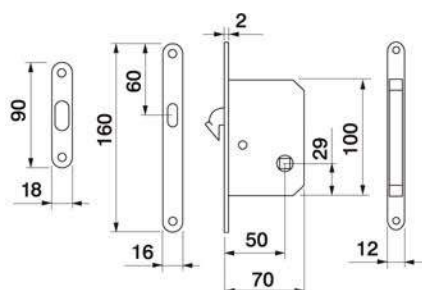

Set di serratura placche incasso con chiave complete di trascinatore
Set of sliding door rose with flush pull, lock and key

ART. 54/B

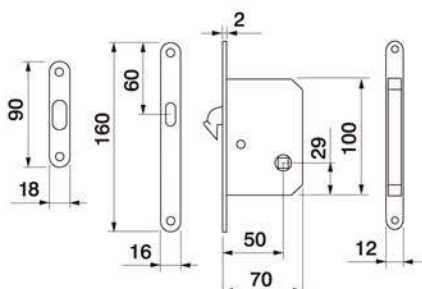
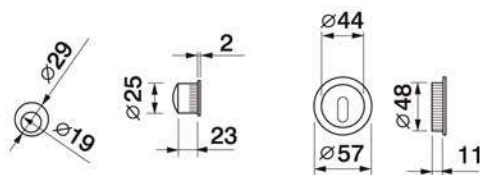

Set di serratura placche incasso con chiave complete di trascinatore
Set of sliding door plate with flush pull, lock and key

ART. 58/B

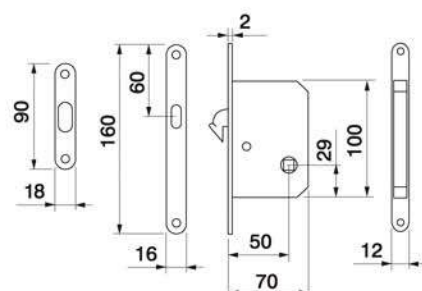
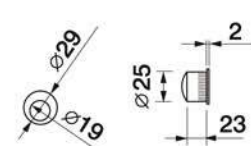

Set di serratura placche incasso con chiave complete di trascinatore
Set of sliding door plate with flush pull, lock and key

ART. 54B/Q

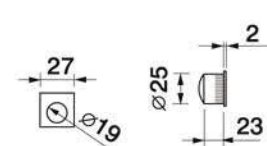

CONTRACT

Finitura

OTL = OTTONE LUCIDO
 OBR = BRONZATO
 CRO = CROMATO
 CSA = CROMATO SATINATO

Finish

OTL = POLISHED BRASS
 OBR = SATIN BRONZE
 CRO = CHROME PLATED
 CSA = SATIN CHROME

ART. IM 1/440



ART. TS 1/407



ART. PI 1/440

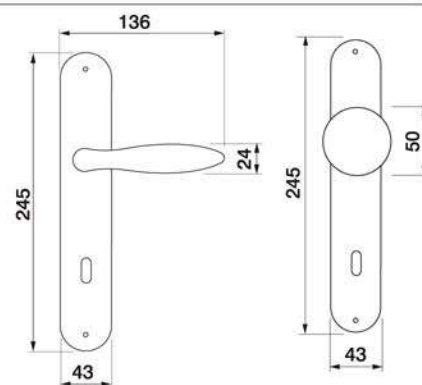
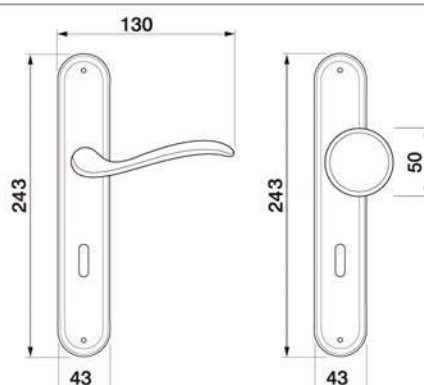
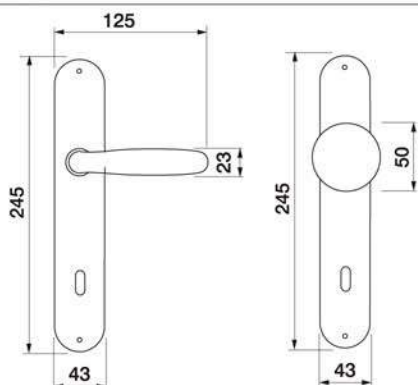

Art. IM 1/440

Maniglia Imola + pomolo 440 fisso con placca
 Imola lever + center knob 440 on plate

Art. TS 1/407

Maniglia Tosca + pomolo 407 fisso con placca
 Tosca lever + center knob 407 on plate

Art. PI 1/440

Maniglia Pisa + pomolo 440 fisso con placca
 Pisa lever + center knob 440 on plate

Finitura

OTL = OTTONE LUCIDO
CRO = CROMATO
CSA = CROMATO SATINATO

CONTRACT

Finish

OTL = POLISHED BRASS
CRO = CHROME PLATED
CSA = SATIN CHROME



ART. 910



ART. 915



ART. 911



ART. 916



ART. 955

ART. 61/M

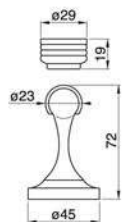
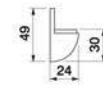
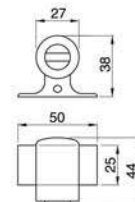
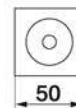
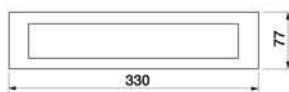
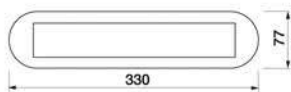

ART. 910
Bucallettere ovale
con aletta
Oval letter plate

ART. 911
Bucallettere ovale
con spazzola
Oval letter plate
with brush

ART. 915
Bucallettere
rettangolare
con aletta
Rectangular
letter plate

ART. 916
Bucallettere
rettangolare
con spazzola
Rectangular
letter plate with brush

ART. 950
Campanello
con rosetta tonda
Bell push
on round rose

ART. 955
Campanello
con rosetta quadra
Bell push
on square rose

ART. 60/M
Fermaporta magneti-
co a pavimento
Floor magnetic
door stop

ART. 60
Fermaporta
a chiocciola
Door stop

ART. 61/M
Fermaporta magneti-
co a parete
Wall magnetic
door stop

LINEA SICUREZZA

SECURITY LINE

La serie Linea di sicurezza è personalizzabile dal cliente che ha la possibilità di scegliere la maniglia che preferisce. Disponibile nella versione maniglia/maniglia oppure maniglia/pomolo.

The security Line can be available with any lever from our range in the version lever/lever or lever/knob.

Finitura

OTL = OTTONE LUCIDO
OBR = BRONZATO
CRO = CROMATO
CSA = CROMATO SATINATO

Finish

OTL = POLISHED BRASS
OBR = SATIN BRONZE
CRO = CHROME PLATED
CSA = SATIN CHROME



ART. 6

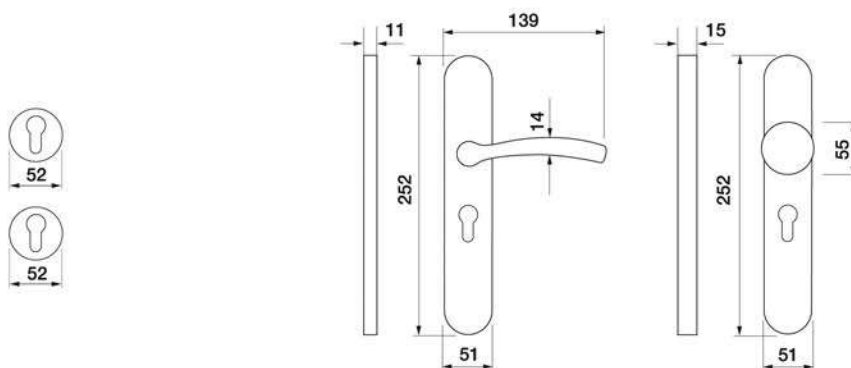

ART. 6

Bocchetta di sicurezza tonda
Square security escutcheon cylinder profile

Linea Sicurezza Benaco
Security line Benaco

Finitura

OTL = OTTONE LUCIDO
OBR = BRONZATO
CRO = CROMATO
CSA = CROMATO SATINATO

Finish

OTL = POLISHED BRASS
OBR = SATIN BRONZE
CRO = CHROME PLATED
CSA = SATIN CHROME

LINEA SICUREZZA

SECURITY LINE

La serie Linea di sicurezza è personalizzabile dal cliente che ha la possibilità di scegliere la maniglia che preferisce. Disponibile nella versione maniglia/maniglia oppure maniglia/pomolo.

The security Line can be available with any lever from our range in the version lever/lever or lever/knob.



ART. 8

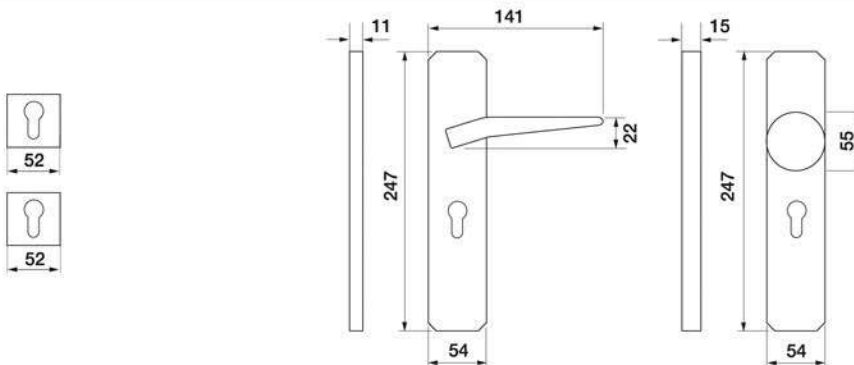

ART. 8

Bocchetta di sicurezza quadrata
Square security escutcheon cylinder profile

Linea Sicurezza Monaco

Security line Monaco

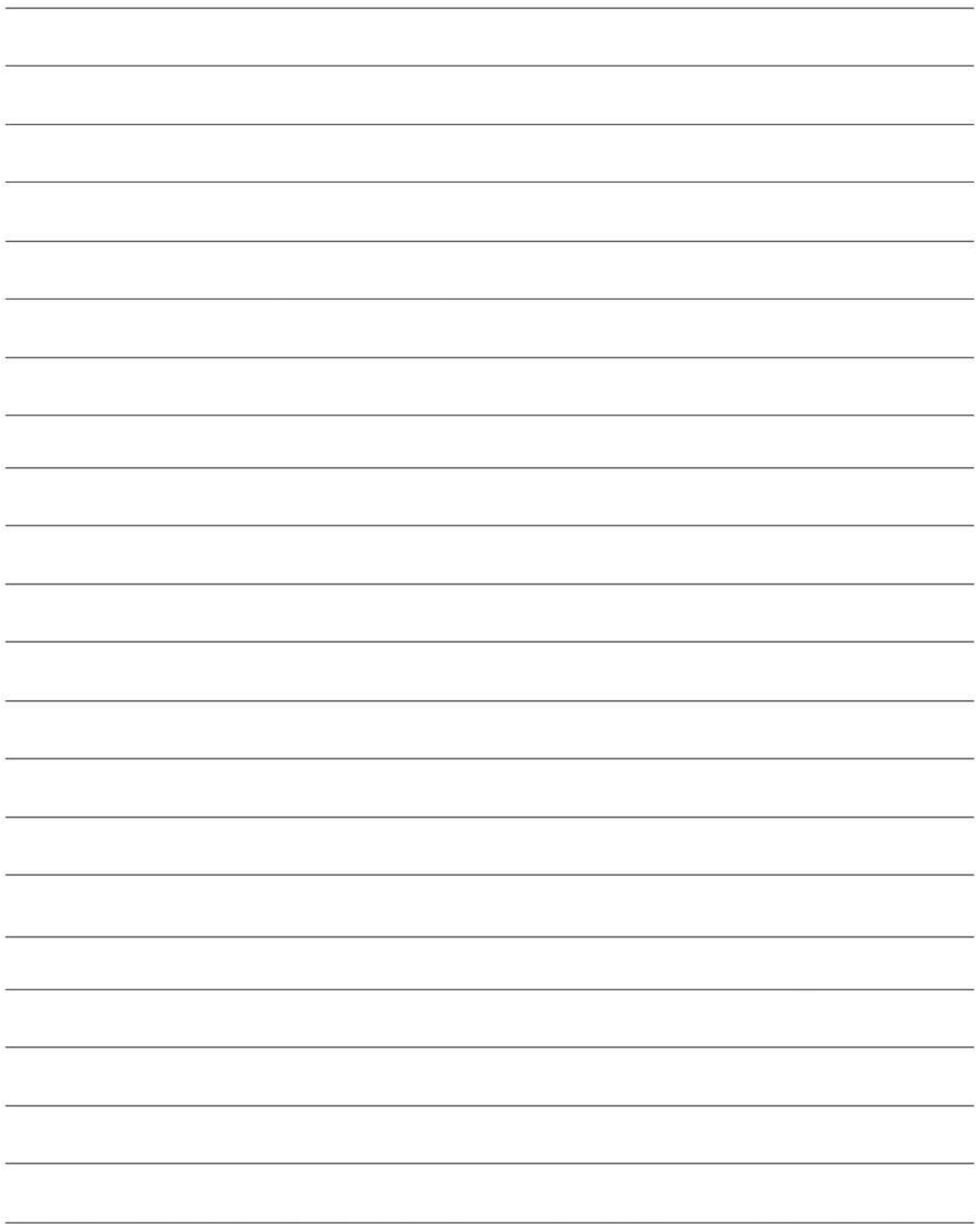

Concept and graphic design
Morelli Design

MORELLI BALTIC - +37060678837
MORELLI EASTERN EUROPE - +375296535773